



www.herculesstands.com



PRODUCT **CATALOG**



HERCULES STANDS IS COMMITTED TO EFFICIENTLY DEVELOPING ECO-FRIENDLY MATERIALS AND REFINING OUR MANUFACTURING PROCESSES TO FURTHER REDUCE ENERGY CONSUMPTION AND WASTE. OUR PASSIONATE COMMITMENT TO CREATIVE, INNOVATIVE & QUALITY ECO-FRIENDLY PRODUCTS IS STRONGER THAN EVER.

TRUST

SAFE | SECURE | STABLE | STRONG

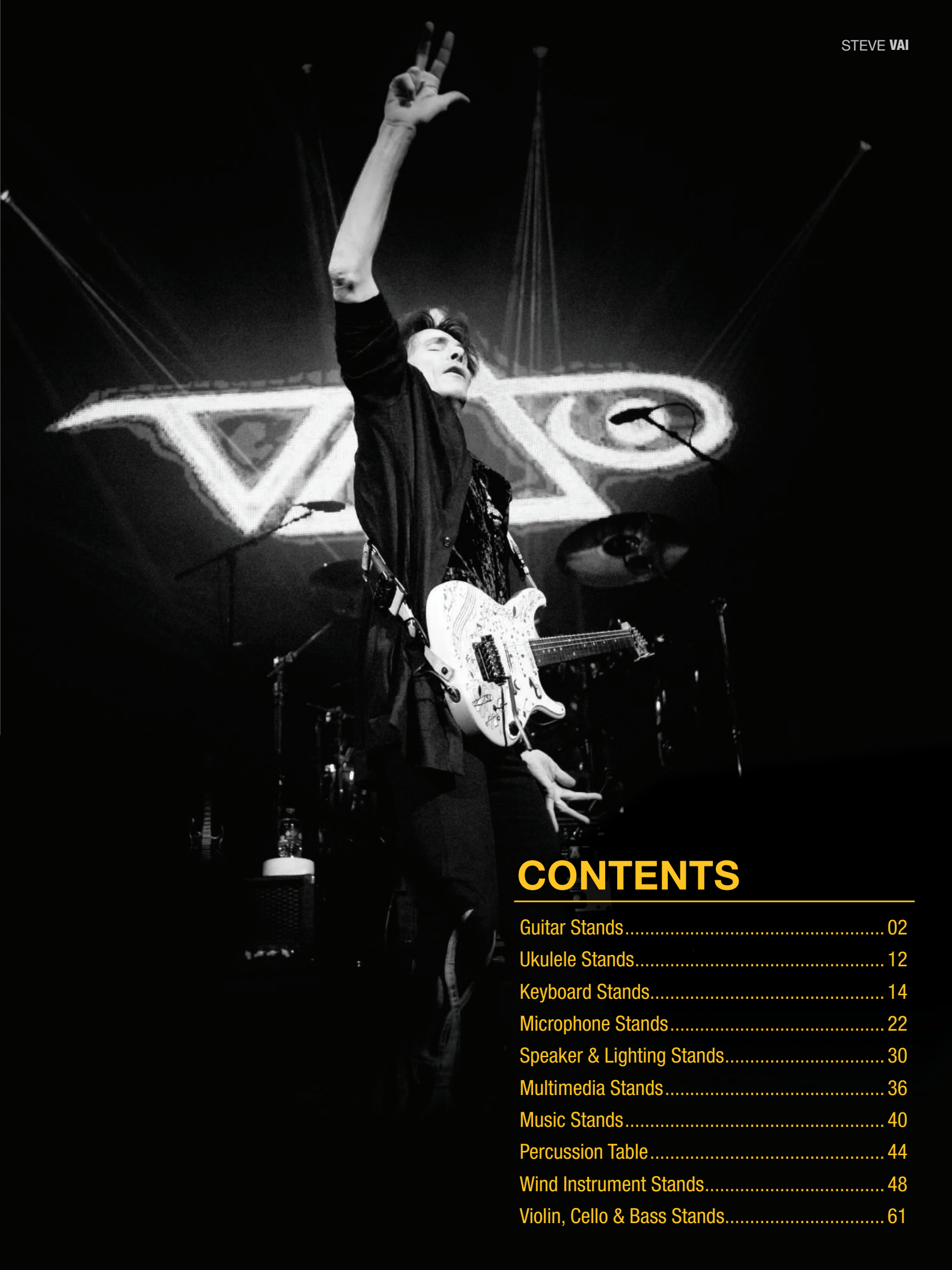

CONTENTS

Guitar Stands.....	02
Ukulele Stands.....	12
Keyboard Stands.....	14
Microphone Stands.....	22
Speaker & Lighting Stands.....	30
Multimedia Stands.....	36
Music Stands.....	40
Percussion Table.....	44
Wind Instrument Stands.....	48
Violin, Cello & Bass Stands.....	61



GUITAR STANDS

HERCULES designed the Auto Grip System with the unique locking system to provide the safest most secure stand for you instrument.

Our Auto Grip System (AGS) is engineered to function easily and is built to last. Specially Formulated Foam (SFF) Rubber is widely used on all contact points between stand and your guitar and is safe for most finishes.



Scan this QR Code with your smartphone and watch the Guitar Stands series.

1 STAND FOR ACOUSTIC & ELECTRIC GUITARS



Compact Fold Design

GS200B

EZPack Guitar Stand

(Patented)

GS200B features a patented design that fits both acoustic and electric guitars, hard rubber contact points that protect your instrument and GS200B folds down small enough to fit in your backpack, instrument case or gig bag.

Features

- » Specially Formulated Foam Rubber fully protects instrument at all contact points
- » The compact size and lightweight design folds and unfolds easily, sets up quickly and goes where you go
- » Patented design fits both acoustic and electric guitars

Specifications

Height: 240 mm (9.5")

Weight: 0.5 kg (1.1 lbs.)

Load Capacity: 10 kg (22 lbs.)

Folded Size: 260 mm × 110 mm × 43 mm
(10.2" × 4.3" × 1.7")

Base Radius: 400 mm × 280 mm
(15.7" × 11")



GS412B PLUS

The Single AGS PLUS guitar stand features our upgraded AGS yoke with SFF rubber, instant height adjustment clutch, N.I.N.A™ (Narrow Neck Instrument Adjustment), and multi-angle adjustable folding back rest.

Features

- » The built-in Auto Grip System safely locks instrument in place
- » Instant Height Adjustment Clutch with locking pin adjusts stand height quickly, easily and securely
- » The Folding Back Rest supports instrument securely, has multi-angle position adjustment and folds up securely for travel
- » Specially Formulated Foam Rubber fully protects instrument at all contact points

Specifications

Nut Width Range: 40 mm - 52 mm
(1.57" - 2.05")

Height: 855 mm - 1075 mm
(33.6" - 42.3")

Weight: 1.7 kg (3.7 lbs)

Base Radius: 320 mm (12.6")

Load Capacity: 15 kg (33 lbs)

Folded Size:

740 mm x 110 mm x 170 mm
(29.1" x 4.3" x 6.7")

Accessories: 1 pair N.I.N.A™ (HA301)

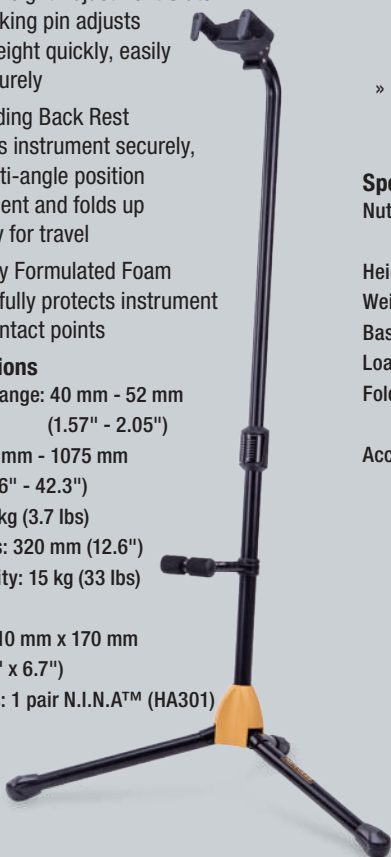

GS414B PLUS

The Single AGS PLUS guitar stand features our upgraded AGS yoke with SFF rubber, instant height adjustment clutch, N.I.N.A™ (Narrow Neck Instrument Adjustment), and multi-angle adjustable folding back rest.

Features

- » The built-in Auto Grip System safely locks instrument in place
- » Instant Height Adjustment Clutch with locking pin adjusts stand height quickly, easily and securely
- » Specially Formulated Foam Rubber fully protects instrument at all contact points

Specifications

Nut Width Range: 40 mm - 52 mm
(1.57" - 2.05")

Height: 950 mm - 1150 mm (37.4" - 45.2")

Weight: 1.88 kg (4.1 lbs)

Base Radius: 310 mm (12.2")

Load Capacity: 15 kg (33 lbs)

Folded Size: 710 mm x 155 mm x 110 mm
(27.9" x 6.1" x 4.3")

Accessories: 1 pair N.I.N.A™ (HA301)



GS415B PLUS

The Single AGS PLUS guitar stand features our upgraded AGS yoke with SFF rubber, instant height adjustment clutch, N.I.N.A™ (Narrow Neck Instrument Adjustment).

Features

- » The folding built-in Auto Grip System safely locks instrument in place
- » Instant Height Adjustment Clutch with locking pin adjusts stand height quickly, easily and securely
- » Specially Formulated Foam Rubber fully protects instrument at all contact points

Specifications

Nut Width Range: 40 mm - 52 mm
(1.57" - 2.05")

Height: 960 mm - 1,150 mm
(37.8" - 45.3")

Weight: 2 kg (4.4 lbs)

Base Radius: 320 mm (12.6")

Load Capacity: 15 kg (33 lbs)

Folded Size:

685 mm x 110 mm x 100 mm
(27" x 4.3" x 3.9")

Accessories: 1 pair N.I.N.A™ (HA301)



Auto Grip System

The Auto Grip System PLUS is driven by the weight of Guitar or Bass.



The AGS PLUS has been engineered with a smooth-sliding channel, main body and two arms with SFF rubber.

When the instrument is placed on the yoke, the channel slides down and rotates two arms holding and protecting your guitar.

To take the guitar, simply lift the instrument out of the housing, two arms release immediately. Fits guitars with neck from 40 mm – 52 mm (1.57" – 2.05").



Narrow Instrument Neck Adjustment (N.I.N.A™) adapters are specially designed to reduce the distance between the AGS arms.



Foldable Auto Grip System Yoke Supports a wide variety of instruments and folds up securely for travel.



Adjustable Folding Back Rest The multi-angle folding back rest supports a wide variety of instruments and folds up securely for travel.

GS422B PLUS

The duo AGS PLUS guitar stand features our upgraded AGS yoke with SFF rubber, instant height adjustment clutch, N.I.N.A™ (Narrow Neck Instrument Adjustment), and multi-angle adjustable folding back rest.

Features

- » Two folding built-in Auto Grip System safely locks instrument(s) in place
- » Instant Height Adjustment Clutch with locking pin adjusts stand height quickly, easily and securely
- » The Folding Back Rest supports instrument securely, has multi-angle position adjustment and folds up securely for travel
- » Specially Formulated Foam Rubber fully protects instrument at all contact points

Specifications

Nut Width Range: 40 mm - 52 mm
(1.57" - 2.05")

Height: 905 mm - 1,130 mm
(35.6" - 44.5")

Weight: 2.6 kg (5.7 lbs)

Base Radius: 430 mm (16.9")

Load Capacity: 20 kg (44 lbs)

Folded Size: 780 mm x 130 mm x 115 mm
(30.7" x 5.1" x 4.5")

Accessories: 1 pair N.I.N.A™ (HA301)



GS432B PLUS

The tri AGS PLUS guitar stand features our upgraded AGS yoke with SFF rubber, instant height adjustment clutch, N.I.N.A™ (Narrow Neck Instrument Adjustment), and multi-angle adjustable folding back rest.

Features

- » Three folding built-in Auto Grip system safely locks instrument(s) in place
- » Instant Height Adjustment Clutch with locking pin adjusts stand height quickly, easily and securely
- » The Folding Back Rest supports instrument securely, has multi-angle position adjustment and folds up securely for travel
- » Specially Formulated Foam Rubber fully protects instrument at all contact points

Specifications

Nut Width Range: 40 mm - 52 mm
(1.57" - 2.05")

Height: 905 mm - 1,130 mm
(35.6" - 44.5")

Weight: 2.98 kg (6.6 lbs)

Base Radius: 430 mm (16.9")

Load Capacity: 30 kg (66 lbs)

Folded Size: 780 mm x 150 mm x 150 mm
(30.7" x 5.9" x 5.9")

Accessories: 1 pair N.I.N.A™ (HA301)



GS526B PLUS

When it comes to shop displays, space is always a premium. HERCULES multi-guitar stand attractively displays up to 6 guitars in a very small footprint. Featuring the upgraded Auto Grip System (AGS), the stand is designed to securely display guitars and offers easy operation.

Features

- » Six folding built-in Auto Grip System safely locks instrument in place
- » Instant Height Adjustment Clutch with locking pin adjusts stand height quickly, easily and securely
- » The Folding Back Rest supports instrument securely, has multi-angle position adjustment and folds up securely for travel
- » Specially Formulated Foam Rubber fully protects instrument at all contact points

Specifications

Nut Width Range: 40 mm - 52 mm
(1.57" - 2.05")

Height: 1,500 mm - 1,900 mm (59" - 74.8")

Weight: 5.4 kg (11.9 lbs)

Base Radius: 530 mm (20.9")

Load Capacity: 40 kg (88 lbs)

Folded Size: 1,220 mm x 160 mm x 160 mm
(48" x 6.3" x 6.3")

Accessories: 2 pair N.I.N.A™ (HA301)



Our goal at HERCULES is to build the best possible instrument stands. Our stands are intended to give you years of trouble-free use. However, guitar manufacturers use many different finish materials and techniques. Therefore, we advise you read the manufacturers warranty and care guide materials for instructions on the proper care and maintenance of your instrument.

GS523B

Multi-Guitar Rack - 3

GS523B accommodates three guitars with Specially Formulated Foam Rubber on all contact points.

Features

- » One-piece design sets up and tears down easily
- » Unique Guitar Yoke designed for acoustic, electric and bass guitars
- » 4 pick slots on each yoke
- » Includes 3 yokes, expands to 6 with HA205

Specifications

Height: 640 mm (25.2")

Weight: 3.6 kg (7.9 lbs.)

Base Radius: 620 mm x 500 mm
(24.4" x 19.7")

Load capacity: 80 kg (176 lbs.)

Folded size: 710 mm x 630 mm x 110 mm
(28" x 24.8" x 4.3")



GS525B

Multi-Guitar Rack - 5

GS525B accommodates five guitars with Specially Formulated Foam Rubber on all contact points.

Features

- » One-piece design sets up and tears down easily
- » Unique guitar yoke designed for acoustic, electric and bass guitars
- » 4 pick slots on each yoke
- » Includes 5 yokes, expands to 10 with HA205

Specifications

Height: 640 mm (25.2")

Weight: 4.4 kg (9.7 lbs.)

Base Radius: 1000 mm x 500 mm
(39.4" x 19.7")

Load capacity: 80 kg (176 lbs.)

Folded size: 1010 mm x 110 mm x 710 mm
(39.8" x 4.3" x 28")

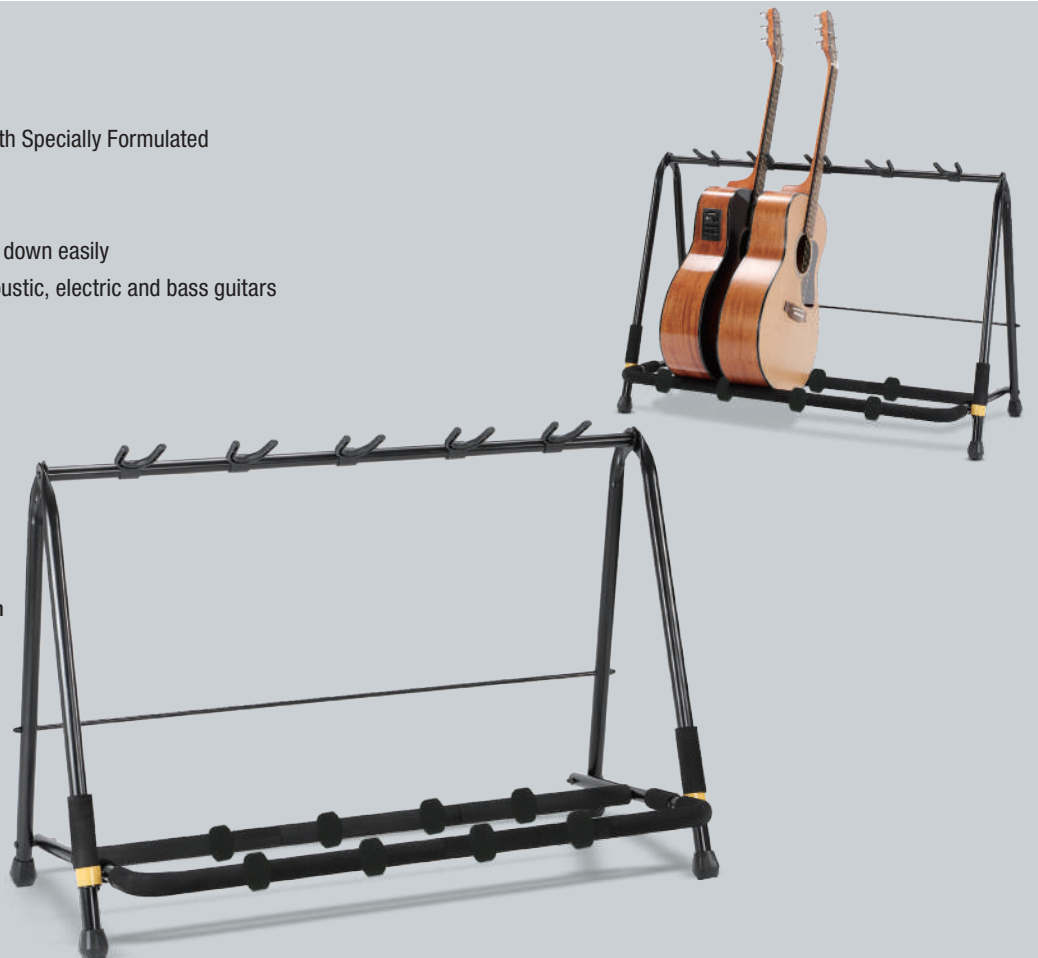

HA205**Extension Pack**

HA205 can double the capacity of either the GS523B or the GS525B. Each extension pack includes one yoke and two rings to add one guitar to your GS523B or GS525B

Features

- » Extension yoke connects easily and securely to GS523B or GS525B



GS523B 3+3=6 Guitars
GS525B 5+5=10 Guitars

**GS405B****SHOKSAFE Guitar Stand**

GS405B features a shock absorbing system with SHOKSAFE tilting post.

Features

- » The SHOKSAFE tilting post and the secure retention system on the upper yoke guard against accidental bumps and collisions
- » The folding bottom yoke locks into position to safely secure instrument in the stand
- » Specially Formulated Foam Rubber fully protects instrument at all contact points

Specifications

Height: 735 mm (28.9")
Weight: 1.9 kg (4.2 lbs.)
Base radius: 270 mm (10.6")
Load capacity: 15 kg (33 lbs.)
Folded size: 675mm x155mm x110mm
(25.4" x 6.1" x 4.3")
Yoke length: 150 mm (5.9")

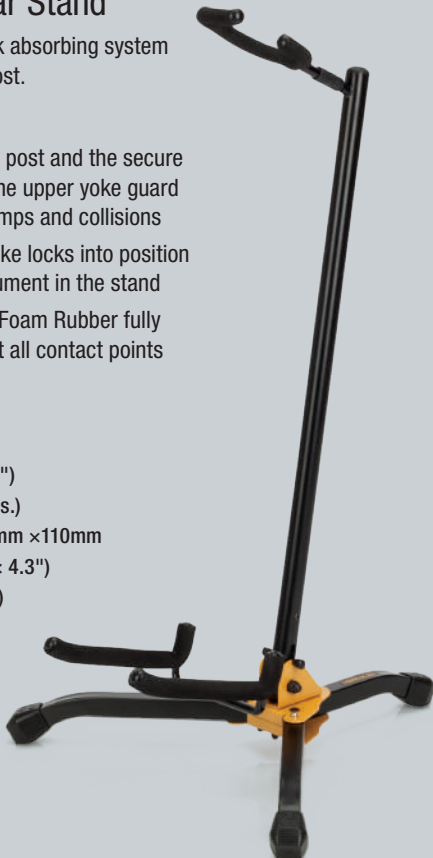
**FS100B****Guitar Foot Rest**

The Foot Rest has a large foot plate with eco-friendly rubber for non-slip support.

Features

- » Height and angle adjusts to 5 positions
- » Large footrest plate
- » Non-slip support, eco-friendly rubber
- » Compact and sturdy

Specifications

Height: 130 mm - 265 mm (5.1" - 10.4")
Weight: 0.8 kg (1.8 lbs.)
Load Capacity: 90 kg (198.4 lbs.)
Folded size: 307mm x138mm x23mm
(12" x 5.4" x 0.9")





GS401BB

Acoustic Guitar Stand

GS401BB Mini Guitar Stand is a stable one-piece stand. It is designed to fold up quickly and pack into the included carry bag.

Features

- » All-in-one design is easy to pack and carry
- » Locking pins on the base function easily and lock securely
- » Specially Formulated Foam Rubber fully protects instruments at all contact points
- » Carry bag included

Specifications

Height: 310 mm (12.2")
 Weight: 0.96 kg (2.1 lbs.)
 Base radius: 260 mm (10.2")
 Load capacity: 15 kg (33 lbs.)
 Folded size: 282 mm x 105 mm x 100 mm (11.1" x 4.1" x 3.9")
 Yoke length: 140 mm (5.5")



GS402BB

Electric/Bass Guitar Stand

GS402BB compact Mini Guitar Stand is a stable one-piece stand. It is designed to fold up quickly and pack into the included carry bag.

Features

- » All-in-one design is easy to pack and carry
- » Locking Pins on the base function easily and lock securely
- » Specially Formulated Foam Rubber fully protects instruments at all contact points
- » Carry bag included

Specifications

Height: 310 mm (12.2")
 Weight: 0.9 kg (1.9 lbs.)
 Base radius: 230 mm (9")
 Load capacity: 15 kg (33 lbs.)
 Folded size: 282mm x 105mm x 100mm (11.1" x 4.1" x 3.9")
 Yoke length: 65 mm (2.6")



Compact Fold Design

GSB001

Guitar Stand Carry Bag

Carry bag for HERCULES Guitar Stands:

GS412B PLUS / GS414B PLUS / GS415B PLUS / GS422B PLUS / GS432B PLUS / GS405B – Also fits: DS730B / DS520B / DS561B / DS580B

Features

- » Heavy-duty nylon
- » Drawstring opening
- » Shoulder strap

Specifications

Size: 800mm x 110mm (31.5" x 4.3")
 Load Capacity: 9 kg (20 lbs.)



TRAVLITE SERIES

The patented HERCULES TravLite Series is designed for touring musicians that demand light, portable, solid stands.



The TravLite guitar stands feature sturdy steel construction and are fully collapsible. These stands fit easily into most gig bags or back packs.

Features

- » Compact slim design folds flat for easy transport
- » Specially Formulated Foam Rubber fully protects instruments at all contact points
- » Non-slip Specially Formulated Rubber Pads adjust to safely accommodate instruments (GS303B Model Only)

GS301B

Acoustic Guitar Stand

GS301B TravLite Acoustic Guitar Stand with sturdy yet light-weight steel construction fits acoustic guitars and most vihuelas.

Specifications

Height: 250 mm (9.8")

Weight: 0.9 kg (2 lbs.)

Base radius: 325 mm x 255 mm (12.8" x 10")

Load capacity: 15 kg (33 lbs.)

Folded size: 300 mm x 245 mm x 50 mm
(11.8" x 9.6" x 1.9")

Yoke depth: 146 mm (5.7")

GS302B

Electric/Bass Guitar Stand

GS302B TravLite Electric/Bass Guitar Stand with sturdy yet light-weight steel construction fits electric/bass guitars.

Specifications

Height: 250 mm (9.8")

Weight: 0.9 kg (2 lbs.)

Base radius: 325 mm x 255 mm (12.8" x 10")

Load capacity: 15 kg (33 lbs.)

Folded size: 300mm x 245mm x 50mm
(11.8" x 9.6" x 1.9")

Yoke depth: 68 mm (2.6")

GS303B

Folk Instrument Stand

GS303B Folk Instrument Stand is solid, sturdy and compact. For banjos, mandolins, ukuleles and violins.

Specifications

Height: 250 mm (9.8")

Weight: 0.9 kg (2 lbs.)

Base radius: 280 mm x 255 mm (11" x 10")

Load capacity: 15 kg (33 lbs.)

Folded size: 260 mm x 245 mm x 100 mm (10.2" x 9.6" x 3.9")

Yoke depth: 90 mm (3.5")



HA206

Stringed Instrument Maintenance Neck Cradle

HA206 holds the instrument neck safely, keeping it stable during the tech process. Height adjustable, accommodates most stringed instruments.

Features

- » Stable, safe, secure positioning
- » Specially Formulated Foam Rubber protects instrument

Specifications

Height: 110 mm – 120 mm (4.3" – 4.7")

Weight: 0.2 kg (0.5 lbs.)

Load Capacity: 15 kg (33 lbs.)

Folded size: 120mm x 155mm x 35mm (4.7" x 6.1" x 1.4")



Compact Fold Design



HA101S

Lock for AGS Stands/Hangers

Features

- » Locks instruments in AGS stands
- » 1 lock + 2 keys per package
- » 24 packages per counter display box

HA201

Lock for AGS Stands/ Hangers - Dealer Pack

Features

- » 12 locks + 3 keys in a package
- » Protects and secures instrument in stand
- » Prevents unwanted handling of instruments
- » Deters theft



HA301

Narrow Instrument Neck Adjustment (NINA™)

Features

- » Increases the thickness of AGS arms.
- » Accommodates narrow neck instruments (like banjos and mandolins) and different neck sizes from min. 28 mm (1.1")
- » Suitable for plus series guitar stands & hangers (e. g. GS414B PLUS)



AutoSwivel Yoke Hangers

Supports symmetric and asymmetric guitar necks that allows for multi-angle adjustments while safely locking instrument in place.

Arm Length from base: 105 mm (4.1"), Load capacity: 7 kg (15.4 lbs.)

GSP38WB PLUS Wall mount with screws



Accessories: 1 pair N.I.N.A™ (HA301)

GSP38WBK PLUS Wall mount with screws

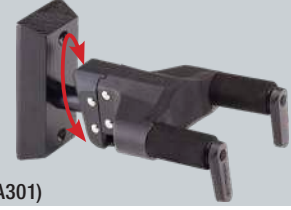

Accessories: 1 pair N.I.N.A™ (HA301)

GSP38WBR PLUS Wall mount with screws



Accessories: 1 pair N.I.N.A™ (HA301) Exclusive offer within certain regions

GSP38WBW PLUS Wall mount with screws



Accessories: 1 pair N.I.N.A™ (HA301) Exclusive offer within certain regions

GSP39WB PLUS Wall mount with screws



Accessories: 1 pair N.I.N.A™ (HA301)

GSP39SB PLUS Fits slatwall

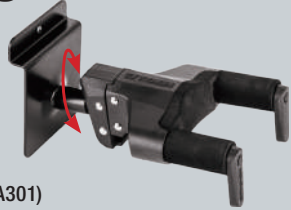

Accessories: 1 pair N.I.N.A™ (HA301)

AutoSwivel and Adjustable Yoke Hangers

The hangers feature both autoswivel and adjustable yoke which pivots left and right so you can display your guitar or bass facing different directions.

Arm length from base: 275 mm (10.8"), load capacity: 7 kg (15.4 lbs.)

GSP40SB PLUS Fits slatwall

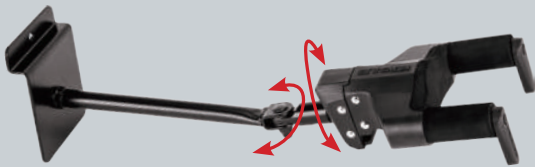

Accessories: 1 pair N.I.N.A™ (HA301)

GSP40WB PLUS Wall mount with screws

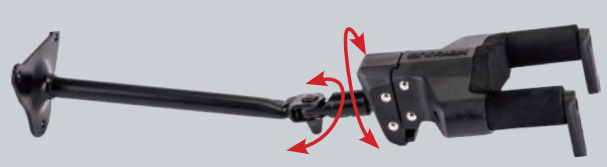

Accessories: 1 pair N.I.N.A™ (HA301)

GSP40B PLUS Fits pegboard

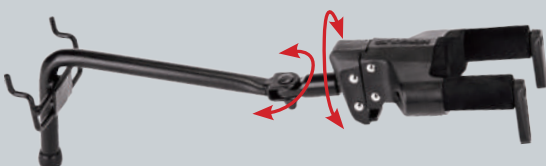

Accessories: 1 pair N.I.N.A™ (HA301)

GSP40HB PLUS Fits gridwall

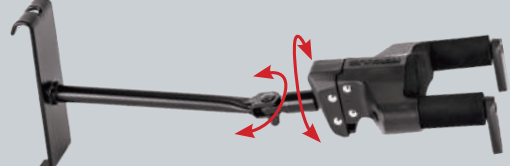

Accessories: 1 pair N.I.N.A™ (HA301)

GSP50HB PLUS Fits gridwall

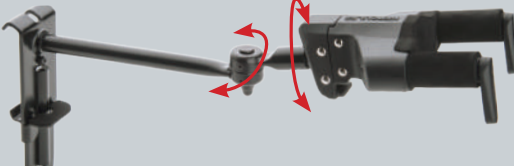

Accessories: 1 pair N.I.N.A™ (HA301)

GSP50SB PLUS Fits slatwall

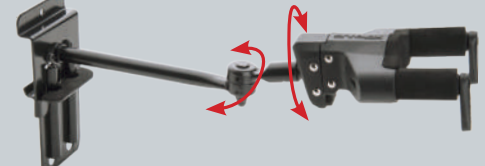

Accessories: 1 pair N.I.N.A™ (HA301)

A photograph of a ukulele on a stand in a rustic room. The room features a large window with a black frame, a brown leather tufted chair, a brick wall, and a wooden floor. A black metal shelving unit is visible in the background. A ukulele is mounted on a black stand in the foreground. A white bag with text is on the floor to the right.

UKULELE STANDS

For decades, Hercules Stands has been offering the most advanced protection for countless guitars around the world. With our innovative Auto Grip System, the instruments are safely locked-in and well supported. Now, this technology has been incorporated into the new ukulele series to ensure your priceless ukuleles are held and protected like no other.

UKS100B

UKULELE Stand

The Ukulele Stand UKS100B features the foldable Auto Grip System (AGS) yoke, Instant Height Adjustment Clutch and Specially Formulated Foam (SFF) rubber on all contact points.

Features:



Foldable Auto Grip System safely locks ukulele in place



Instant height adjustment clutch with locking pin adjusts stand height quickly, easily and securely

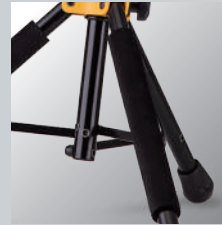

Specially Formulated Foam (SFF) rubber fully protects your instrument on all contact points



The stand folds up compactly for easy transport and storage



Specifications:

Height: 575 mm-815 mm (22.6"-32.1")

Weight: 0.8 kg (1.8 lbs.)

Base Radius: 210 mm (8.3")

Load Capacity: 4 kg (8.8 lbs.)

Folded Size: 475 mm x 90 mm x 80 mm (18.7" x 3.5" x 3.1")



USP20CB

UKULELE CLAMP

The Ukulele Clamp USP20CB features the Auto Grip System (AGS) yoke and a fully adjustable clamp that can be attached to a round or square tube and desks.

Specifications

Weight: 0.4 kg (0.9 lbs.)

Load Capacity: 4 kg (8.8 lbs.)

Folded Size: 90 mm x 75 mm x 230 mm
(3.54" x 2.95" x 9.06")



USP10WB

UKULELE HANGER Wall mount with screws

The Ukulele Hanger USP10WB features the Auto Grip System (AGS) yoke and an attractive wood base for home or studio use.

Specifications

Arm Length: 100 mm (3.9")

Load Capacity: 4 kg (8.8 lbs.)



USP10SB

UKULELE HANGER Fits slatwall

The Ukulele Hanger USP10SB features the Auto Grip System (AGS) yoke and a slatwall base for display use.

Specifications

Arm Length: 100 mm (3.9")

Load Capacity: 4 kg (8.8 lbs.)



HOLLY LAESSIG (L) / JESS WOLFE (R)
LUCIUS

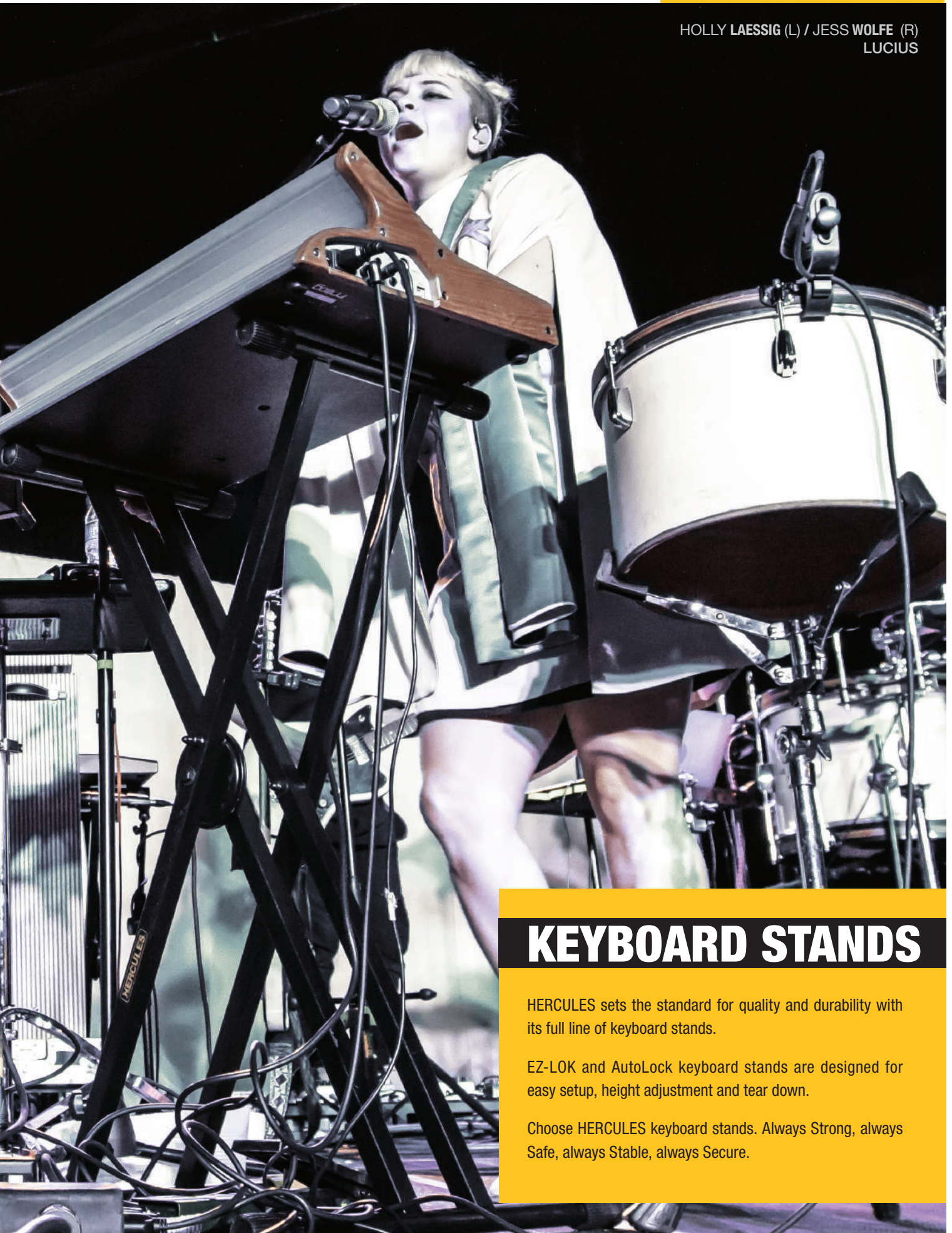

KEYBOARD STANDS

HERCULES sets the standard for quality and durability with its full line of keyboard stands.

EZ-LOK and AutoLock keyboard stands are designed for easy setup, height adjustment and tear down.

Choose HERCULES keyboard stands. Always Strong, always Safe, always Stable, always Secure.

TRAVLITE SERIES

KS118B

TravLite Keyboard Stand

Compact, one-piece design that travels well.

Features

- » Trigger height adjustment with six settings
- » Quick and easy set up and tear down

Specifications

Weight: 3.4 kg (7.5 lbs.)

Load Capacity: 80 kg (176.4 lbs.)

Folded Size: 970 mm x 150 mm x 80mm
(38.1" x 5.9" x 3.2")



Trigger Adjuster

An Adjustable Rubber Foot is fitted and provides stability on uneven floors.

KEYBOARD STAND HEIGHT & WIDTH POSITIONS

Position	Height	KS100B Width	KS118B Width
A	540 mm (21.3")	875 mm (34.4")	850 mm (33.5")
B	660 mm (26")	790 mm (31.1")	770 mm (30.3")
C	770 mm (30.3")	685 mm (26.9")	665 mm (26.2")
D	860 mm (33.9")	565 mm (22.2")	550 mm (21.7")
E	930 mm (36.6")	430 mm (16.9")	420 mm (16.5")
F	980 mm (38.6")	290 mm (11.4")	285 mm (11.2")

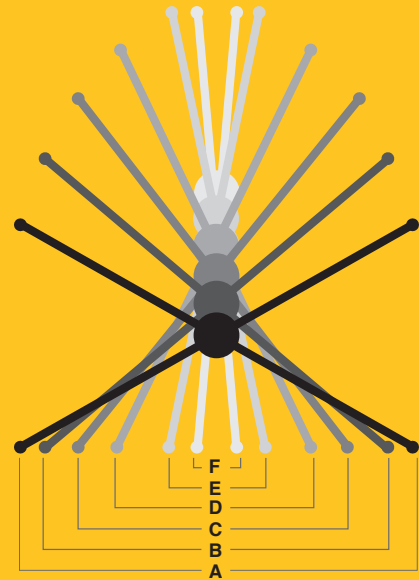

KSB001

Carrying bag for KS118B

Specifications

Size: 1030 mm x 125 mm x 100 mm (40.5" x 4.9" x 3.9")

Load Capacity: 10 kg (22 lbs.)



KS210B

Double Tier X Keyboard Stand

Features

- » Patented EZ-LOK System with 4-height settings
- » Heavy-duty round and square steel tubes with a durable finish
- » 2nd tier adjusts simultaneously while setting the base height and is slightly tilted for comfort
- » Adjustable rubber foot provides stability

Specifications

Weight: 8.4 kg (18.5 lbs.)

Upper tier depth: 340 mm (13.4"); Load capacity: 40 kg (88 lbs.)

Lower tier depth: 400 mm (15.76"); Load capacity: 80 kg (176.4 lbs.)

Folded size: 1115 mm x 505 mm x 115 mm (43.8" x 19.9" x 4.5")

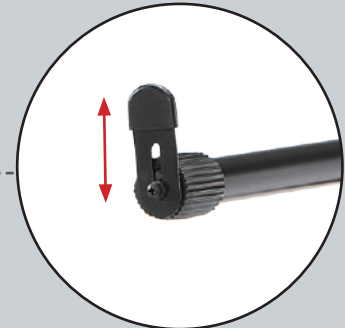

Adjustable stopper accommodates different size keyboards.

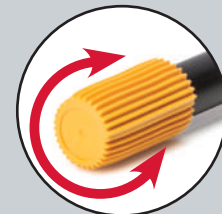

An adjustable rubber foot is fitted and provides stability on uneven floors.

HEIGHT AND WIDTH POSITIONS

Position	Lower Tier		Upper Tier	
	Height	Width	Height	Width
1	610 mm (24")	810 mm (31.9")	Only at Setting D- 300 mm (11.8")	775 mm (30.2")
2	750 mm (29.5")	690 mm (27.2")	*Full range settings	665 mm (26")
3	865 mm (34")	550 mm (21.7")	*Full range settings	530 mm (20.6")
4	950 mm (37.4")	390 mm (15.4")	*Full range settings	370 mm (14.4")

Upper Tier Height Settings: A=200 mm (7.9"), B=225 mm (8.9"), C=250 mm (9.8"), D=275 mm (10.8"), E=300 mm (11.8")

KS100B

Single X Keyboard Stand

Features

- » EZStep foot pedal for 6 easy and quick height settings
- » Collapsible and foldable design, storage size much smaller than standard keyboard stands.

Specifications

Weight: 3.35 kg (7.2 lbs.)

Load Capacity: 80 kg (176.4 lbs.)

Folded Size: 976 mm x 83 mm x 70 mm (39" x 3.3" x 2.8")

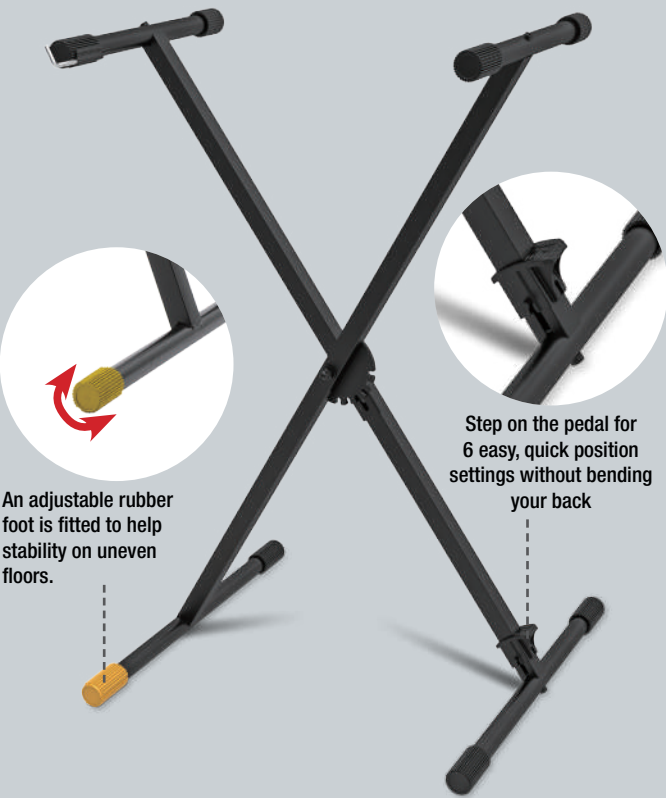

KS110B

Single X Keyboard Stand

Features

- » Patented EZ-LOK System with 5-height settings automatically locks the stand in place
- » Heavy-duty round and square steel tubes and a durable finish
- » Adjustable rubber foot provides stability

Specifications

Height: Refer to page 17

Weight: 3.2 kg (7 lbs.)

Load capacity: 80 kg (176 lbs.)

Folded size: 1,033 mm x 515 mm x 110 mm (40.7" x 20.3" x 4.3")

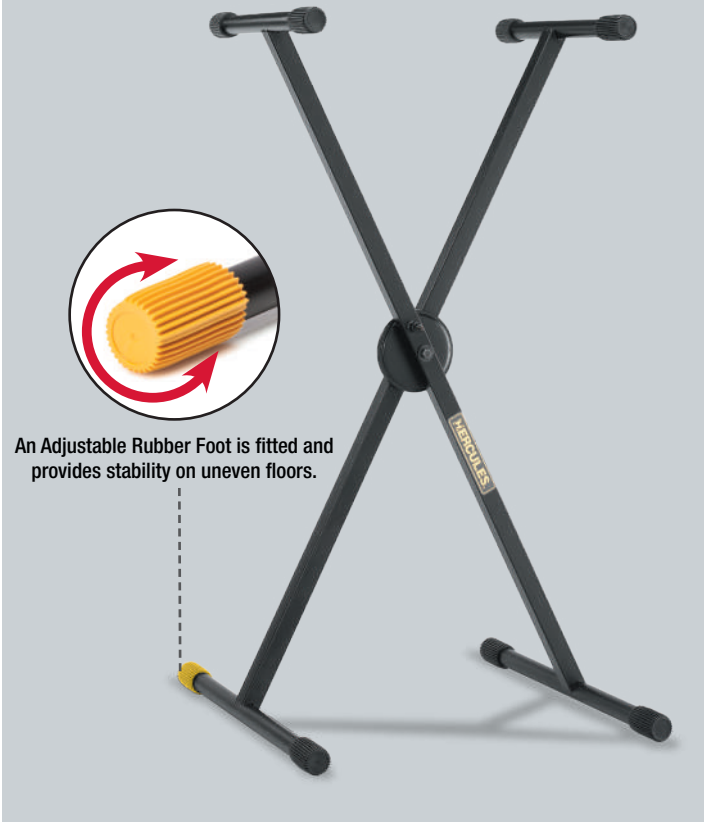

EZ-LOK

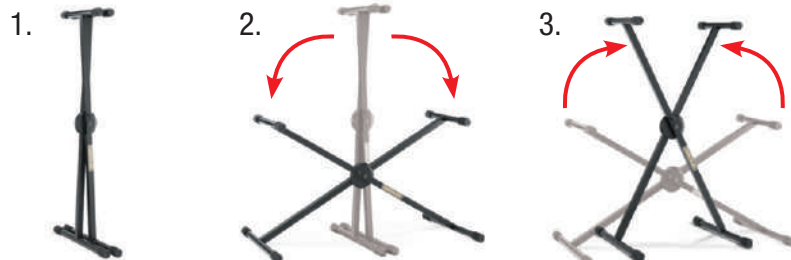

Simply set the stand by 1st closing the stand entirely, 2nd opening it all the way to the lowest level and 3rd raising it to the desired height. The EZ-LOK System automatically locks stand into one of five height settings. No more fussing with screws! Repeat above operation 1-3 to reset the height.

KS120B

Double X Keyboard Stand

The Double X-Style Keyboard Stand features our patented EZ-LOK, 5-height settings, heavy-duty round and square steel tubes and a durable finish. Double braces provide greater strength and stability.

Specifications

Weight: 5.9 kg (13 lbs.)

Load Capacity: 100 kg (220lbs.)

Folded size: 1,033 mm x 515 mm x 110 mm (40.7" x 20.3" x 4.3")

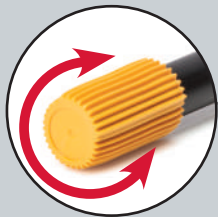

An Adjustable Rubber Foot is fitted and provides stability on uneven floors.



KS110B & KS120B - HEIGHT AND WIDTH SPECIFICATIONS

Position	Height	Width
A	520 mm (20.3")	860 mm (33.5")
B	675 mm (26.3")	750 mm (29.3")
C	805 mm (31.4")	620 mm (24.2")
D	905 mm (35.6")	470 mm (18.3")
E	980 mm (38.6")	290 mm (11.3")

KS110B & KS120B - Height and Width Specifications.

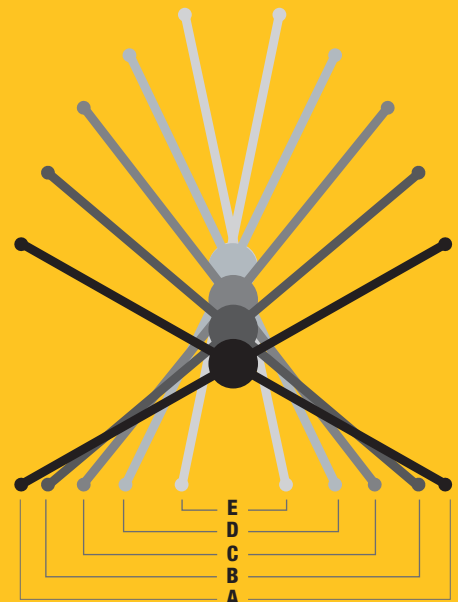

KS400B

AutoLock System Z Keyboard Stand

Features

- » AutoLock System with AutoLock Lever adjusts height setting easily and is safe and secure
- » Locking Pins and adjustable moving arms for easy set up and tear down
- » The Adjustable Rubber Foot fine tunes height and levels the KS400B for maximum stability

Specifications

Height: 605 mm — 930 mm (23.8" — 36.6")

Width: 510 mm — 850 mm (20" — 33.5")

Weight: 7.5 kg (16.5 lbs.)

Load capacity: 130 kg (286 lbs.)

Folded size: 705 mm x 605 mm x 175 mm (27.7" x 23.8" x 6.9")

Support depth: 450 mm (17.7")

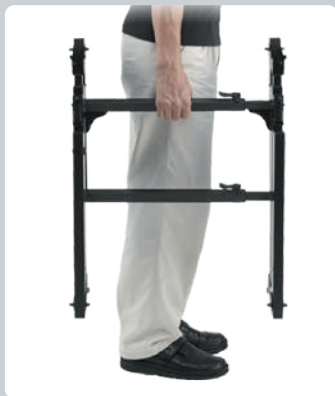

One-piece design folds up compactly.



KB200B

EZ Height Adjust Keyboard Bench

Features

- » EZ Height Adjustment lever with 4 height settings
- » Micro Adjuster fine tunes height setting
- » The Adjustable Rubber Foot provides stability on uneven floors

Specifications

Seat size: 600 mm x 320 mm (23.6" x 12.6")

Height settings: 480 mm, 510 mm, 530 mm, 560 mm
(18.9", 20.1", 20.9", 22")

Weight: 6.5 kg (14.3 lbs.)

Load capacity: 150 kg (330 lbs.)

Folded size: 747 mm x 380 mm x 170 mm
(29.4" x 15" x 6.7")

Micro Adjuster

The HERCULES Micro Adjuster lets you fine tune the height for more comfortable sitting. Turn the knob for up to 8 cm (3.14") of additional adjustment.

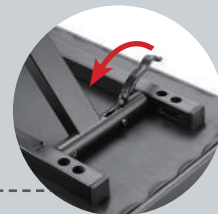

EZ Height Adjustment

(Patented)

The built-in spring system allows you to quickly jump from one height setting to the next. Just pull the lever to switch between 4 preset seat heights.

KS410B

Double Tier Z Keyboard Stand

Features

- » AutoLock System with AutoLock Lever adjusts height setting easily and is safe and secure
- » Locking Pins and adjustable moving arms for easy set up and tear down
- » The Adjustable Rubber Foot fine tunes height and levels the KS410B for maximum stability

Specifications

Weight: 11.6 kg (25.5 lbs.)
 Folded size: 705 mm × 605 mm × 175 mm
 (27.7" × 23.8" × 6.9")
 Load Capacity: 130 kg (286 lbs.)

Base Z

Specifications

Height: 605 mm - 930 mm (23.8" - 36.6")
 Width: 510 mm - 850 mm (20" - 33.5")
 Support depth: 450 mm (17.7")

Upper Tier

Specifications

Height: 240 mm - 430 mm (9.4" - 16.9")
 Depth: 400 mm (15.7")
 Angle: 70°, 90°
 Load Capacity: 40 kg (88 lbs.)



Adjustable Stopper accommodates a variety of keyboard sizes.



Adjustable rubber foot for height fine tuning and stable leveling.



AutoLock System

(Patented)

- » One touch height setting
- » Lift up both arms and the AutoLock sets securely at required height
- » Press the lever to lower or to pack away



Locking Pins

- » Located on the keyboard resting arms and the stand legs, locking pins allow quick and secure set up
- » To pack away, press the pins and flip out the arms

TOBIAS SAMMET
EDGUY/AVANTASIA



MICROPHONE STANDS

HERCULES Quik-N-EZ microphone stands and booms have innovative designs that are safe, secure, solid and stable.

HERCULES Quik-N-EZ microphone stands offer new and state-of-the-art approaches providing stands that are incredibly versatile and easy to use!

Photo Thorsten Doerr



MS432B

Quick Turn Tripod Microphone Stand

Features

- » Stage Series
- » 2-in-1 Boom Clamp and Quick-Turn Clutch
- » Durable aluminum die-cast with tripod legs

Specifications

Height: 875 mm – 1475 mm (34.4" – 58.1")

Weight: 2.2 kg (4.9 lbs.)

Base radius: 630 mm (24.8")

Boom length: 780 mm (30.7")

Folded size: 805 mm × 95 mm × 95 mm
(31.7" × 3.7" × 3.7")



2-in-1 Boom Clamp

HERCULES 2-in-1 Boom Clamp is specially designed to adjust boom length and angle at the same time. Just loosen the knob and slide post into your desired position.

MS202B

Quick Turn H-Base Microphone Stand

Features

- » Stage Series
- » Quick Turn Clutch
- » HERCULES H-Base

Specifications

Height: 920 mm – 1680 mm (36.2" – 66.1")

Weight: 3.4 kg (7.5 lbs.)

Base radius: 120 mm (4.7")

Folded size: 910 mm × 266 mm × 35 mm
(35.8" × 10.5" × 1.4")



HERCULES Round H-Base

Weighted for maximum stability and dampens vibrations.

STAGE Series Microphone Stands

Features

- » Quick Turn Clutch
- » Lightweight and durable
- » Fast and easy set up and tear down



Quick Turn - Simply turn one quarter for quick and easy height adjustment.

MS532B

EZ Clutch Tripod Microphone Stand

Features

- » EZ Mic Clip, 2-in-1 Boom Clamp and EZ Clutch
- » Durable aluminum die-cast base with tripod legs

Specifications

Height: 1045 mm - 1680 mm (41.1" - 66.1")

Weight: 2.6 kg (5.7 lbs.)

Base radius: 340 mm (13.4")

Boom length: 780 mm (30.7")

Folded size: 885 mm × 95 mm × 95 mm
(34.8" × 3.7" × 3.7")



MS632B

EZ Grip Tripod Microphone Stand

Features

- » EZ Mic Clip, 2-in-1 Boom Clamp and Quik-N-EZ Height Adjustment Grip
- » Durable aluminum die-cast base with tripod legs

Specifications

Height: 1115 mm - 1680 mm (43.9" - 66.1")

Weight: 2.97 kg (6.5 lbs.)

Base radius: 340 mm (13.4")

Boom length: 780 mm (30.7")

Folded size: 965 mm x 90 mm x 90 mm
(38" x 3.5" x 3.5")



EZ Clutch

Press for a quick height adjustment. EZ Clutch releases to lock for secure and stable positioning.



Quik-N-EZ Height Adjustment Grip

(Patented)

Fast one-handed height adjustments

MS531B**EZ Clutch Tripod Mic Stand****Features**

- » EZ Mic Clip, EZ Boom Retainer and EZ Clutch
- » Durable aluminum die-cast base with tripod legs

Specifications

Height: 1045 mm - 1680 mm (41.1" - 66.1")
 Weight: 2.6 kg (5.7 lbs.)
 Boom length: 780 mm (30.7")
 Base radius: 340 mm (13.4")
 Folded size: 885 mm × 95 mm × 95 mm
 (34.8" × 3.7" × 3.7")

**MS631B****EZ Grip Tripod Mic Stand****Features**

- » EZ Mic Clip, EZ Boom Retainer and Quik-N-EZ Height Adjustment Grip
- » Durable aluminum die-cast base with tripod legs

Specifications

Height: 1115 mm - 1680 mm (43.9" - 66.1")
 Weight: 3 kg (6.6 lbs.)
 Boom length: 780 mm (30.7")
 Base radius: 340 mm (13.4")
 Folded size: 965 mm × 90 mm × 90 mm
 (38" × 3.5" × 3.5")

**Quik-N-EZ Boom Retainer**

Flip the lever of EZ retainer up or down to mount the boom to the floor stand.

**2-in-1 Boom**

Easily adjust boom length and angle at the same time.

MS533B

EZ Clutch Tripod Base Hideaway Boom Stand

MS533B Tripod Base Hideaway Boom Stand can easily be converted to a boom or straight stand.

Features

- » EZ Mic Clip
- » EZ Clutch
- » 2-in-1 Boom Clamp
- » Durable aluminum die-cast base with tripod legs

Specifications

Height: 1070 mm - 2400 mm (42.1" - 94.5")

Weight: 2.6 kg (5.7 lbs.)

Boom length: 780 mm (30.7")

Base radius: 340 mm (13.4")

Folded size: 980 mm × 95 mm × 95 mm (38" × 3.7" × 3.7")



Hideaway Boom

Converts easily and quickly to either a boom or straight microphone stand.



MS401B

Transformer Microphone Stand

Features

- » EZ Mic Clip
- » EZ Height Adjustment Grip
- » Tilting base and swivel legs
- » Stand angle is fully adjustable (45°—90° recommended)
- » Swivel legs adjust easily and offer versatile positioning

Specifications

Height: 1030 mm - 1680 mm (40.6" - 66.1")

Weight: 3.6 kg (8 lbs.)

Base radius: 370 mm (14.6")

Folded size: 990 mm × 125 mm × 103 mm (39" × 4.9" × 4")



MS201B

EZ Grip Microphone Stand

Features

- » EZ Mic Clip
- » Quik-N-EZ Height Adjustment Grip
- » Weighted HERCULES H-Base

Specifications

Height: 1010 mm - 1680 mm (40.2" - 66.1")

Weight: 4.3 kg (5.7 lbs.)

Base radius: 120 mm (4.7")

Folded size: 970 mm × 360 mm × 70 mm
(38.2" × 14.2" × 2.8")



Tilting Base and Swivel Legs

(Patented)

Smoothly adjusts to any angle (45° to 90° angles are recommended). Swivel legs nest around other stands and equipment on stage easily and HERCULES Transformer Mic Stand stores and displays well in tight spaces.



H-Base

(Patented)

Weighted for maximum stability and dampens any vibrations.



MS120B

H-Base Microphone Stand

Features

- » EZ Mic Clip, 2-section telescopic boom with HERCULES H-Base
- » Ideal for drum and amp mics in situations with limited floor space

Specifications

Height: 440 mm (17.3")

Weight: 2.9 kg (6.4 lbs.)

Boom length: 440 mm - 800 mm (17.3" - 31.5")

Base radius: 90 mm (3.5")

Folded size: 470 mm × 375 mm × 110 mm
(18.5" × 14.8" × 4.3")



MS540B

Kick Drum Microphone Stand

Features

- » EZ Mic Clip, 2-section telescopic boom on a durable aluminum die-cast base with tripod legs
- » Great for drum and amp microphones

Specifications

Height: 655 mm (25.8")

Weight: 2.1 kg (4.7 lbs.)

Boom length: 780 mm - 1,220 mm (30.7" - 48")

Base radius: 325 mm (12.8")

Folded size: 782 mm × 105 mm × 90 mm
(30.8" × 4.1" × 3.5")



MS100B

H-Base Microphone Stand

Features

- » EZ Mic Clip
- » Quik-N-EZ Height Adjustment Lever
- » HERCULES H-Base

Specifications

Height: 280 mm - 445 mm (11" - 17.5")

Weight: 1.6 kg (3.5 lbs.)

Base radius: 80 mm (3.1")

Folded size: 285 mm × 194 mm × 34 mm
(11.2" × 7.6" × 1.3")



MS300B

Kick Drum Microphone Stand

MS300B Mic Stand is perfect for any low profile application

Features

- » EZ Mic Clip
- » Quik-N-EZ Height Adjustment Lever
- » Tilting base
- » Swivel legs

Specifications

Height: 315 mm - 475 mm
(12.4" - 18.7")

Weight: 1 kg (2.2 lbs.)

Base radius: 170 mm (6.7")

Folded size: 310 mm × 98 mm × 72 mm
(12.2" × 3.9" × 2.8")

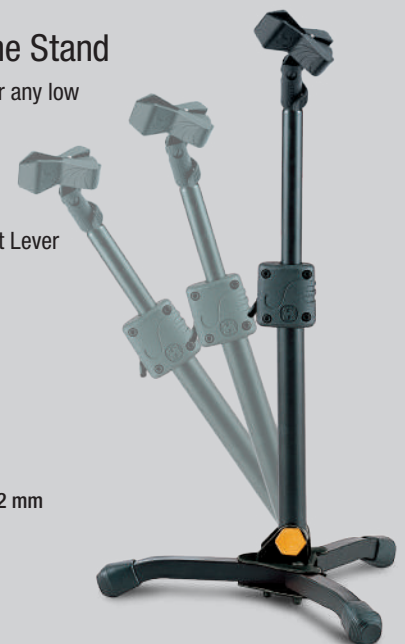

Quik-N-EZ Height Adjustment Lever

(Patented)

Press for a fast and easy height adjustment



ACCESSORIES

MH100B

Quik-N-EZ Microphone Clip

(Patented)

MH100B connects to a mic stand the the flip lever, works well with both threaded and non-threaded stands, rubber-lined for a secure grip

Features

Fits all mic stands without top washers

Specifications

Fits all mic stands without top washers.

Accept mic size: 20 mm - 35 mm

(0.8" - 1.4") O/D

Fit Tubing: 15.9 mm (0.63")

**MH101B**

Quik-N-EZ Microphone Holder

(Patented)

On and off with a flip of a lever, durable rubber holder for a snug and flexible grip fits all mic stands without top washers.

Specifications

Fits all mic stands without top washers.

Accept mic size: 25 mm - 30 mm

(1"- 1.1") O/D

Fit Tubing: 15.9 mm (0.63")

**MSB001**

Speaker & Microphone Combo Stand Bag

Specifications

Before expansion: 1240 mm x 180 mm x 150 mm (18.8" x 7.1" x 6")

2-pc HERCULES Mic Stand **OR** 1-pc HERCULES Speaker Stand (SS400B/ SS410B)

Specifications

After Expansion: 1,240 mm x 245 mm x 150 mm (18.8" x 9.6" x 6")

4-pc HERCULES Mic Stand **OR** 2-pc HERCULES Speaker Stand (SS400B/ SS410B)

OR 1-pc HERCULES Speaker Stand (SS700B/ SS710B)

Specifications

Load Capacity: 20 kg (44 lbs.)

**MH200B**

POP Filter

Features

- » Get the best vocal recordings
- » Double layered mesh screen
- » Easy to attach to microphone stands and booms

Specifications

Diameter: 155 mm (6.1")

Gooseneck Length: 340 mm (13.4")

Net Weight: 280 g (0.62 lbs.)

**HA700**

GUITAR STRAP AND HEADPHONE HOLDER

Features

- » Reduce the risk of tripping over straps on the stage floor
- » The holder can firmly take headphones weighed under 2 kg. (4.4 lbs.)
- » Lightweight and handy, a useful addition for stage, studio, and home
- » Also suitable for guitar & music stands

Specifications

Arm Length: 108 mm (4.2")

Weight: 184 g (0.4 lbs.)

Load Capacity: 2 kg (4.41 lbs.)





SPEAKER & LIGHTING STANDS

HERCULES Quik-N-EZ speaker and lighting stands are engineered for easy setups that save time and effort.

HERCULES provides solutions: The Quik-N-EZ Series offers innovative devices that ensure speaker and lighting set up is painless.



SS200BB

Stage Series Speaker Stands

Includes a pair of stands in a sturdy carrying bag that's ideal for backline and rental companies or touring musicians.

Features

- » Smart Adaptor for 35/38mm speaker pole sockets
- » Tripod leg housing
- » Safety Pin

Specifications

Height: 1280 mm – 2050 mm (50.4" – 80.7")

Weight: 2.7 kg (6 lbs.)

Base radius: 660 mm (26")

Load capacity: 45 kg (99.2 lbs.)

Folded size: 1130 mm × 150 mm × 150 mm
(44.5" × 5.9" × 5.9")

* Measurement of single stand



Smart Adaptor

The new Smart Adaptor is designed to fit 35 / 38mm (1.38" / 1.5") speaker pole sockets with ease. Shift the cover to convert it from a 35mm to 38mm fitting.



SS400B/SS410B

AutoLock Speaker Stand

The HERCULES Auto Lock Speaker Stand SS400B/SS410B features the Quick-N-EZ Auto Lock System, the built-in metal leg housing, all-aluminum tubes, and a safety pin for security.

Features

- » Quik-N-EZ AutoLock
- » Built-In metal leg housing
- » Lightweight all-aluminum tubes
- » Safety pins

SS400B

Specifications

Height: 1,170 mm - 2,100 mm (46.1" - 82.7")
Weight: 2.9 kg (6.4 lbs.)
Base radius: 660 mm (26")
Load capacity: 45 kg (99.2 lbs.)
Folded size: 1163 mm × 150 mm × 125 mm (45.8" × 6" × 5")
Accept flange at 35 mm and 38 mm (1-3/8" and 1-1/2")

SS410B

Specifications

Height: 1170 mm - 2100 mm (46.1" - 82.7")
Weight: 3.5 kg (7.7 lbs.)
Base radius: 660 mm (26")
Load capacity: 45 kg (99.2 lbs.)
Folded size: 1235 mm × 150 mm × 125 mm (48.6" × 6" × 5")
*EZ Adaptor only available in SS410B, and fits any speaker pole mount sized at 35 mm - 40 mm (1.38" - 1.57").



SS400B

SS410B

QUIK-N-EZ SERIES

Quik-N-EZ AutoLock

(Patented)

With the knob on "LOCK", the AutoLock allows you to easily lift the upper tube to the desired height as the design stops the speaker from sliding back down.



Lock Position



Unlock Position

SS700B/SS710B

Gear Up Speaker Stand

The HERCULES Gear Up Speaker Stand SS700B/SS710B features the Quick-N-EZ Gear Up System to raise and lower speakers to desired height and securely locks them in place.

Features

- » Quik-N-EZ Gear Up
- » Built-in metal leg housing
- » Lightweight all-aluminum tubes
- » Reinforced dual-brace leg construction

SS700B

Specifications

Height: 1150 mm - 2180 mm (45.3" - 85.9")

Weight: 6.2 kg (13.7 lbs.)

Base radius: 660 mm (26")

Load capacity: 45 kg (99.2 lbs.)

Folded size: 1165 mm × 210 mm × 190 mm (46" × 8.3" × 7.5")

Accept flange at 35 mm and 38 mm (1-3/8" and 1-1/2")

SS710B

Specifications

Height: 1150 mm - 2180 mm (45.3" - 85.9")

Weight: 6.8kg (15 lbs.)

Base radius: 660 mm (26")

Load capacity: 45 kg (99.2 lbs.)

Folded size: 1235 mm × 210 mm × 190 mm

(48.4" × 8" × 7.5")

*EZ Adaptor only available in SS710B, and fits any speaker pole mount sized at 35 mm - 40 mm (1.38" - 1.57").



SS100B

EZ Speaker Stand Adaptor

(Patented)

Features

- » Secures the speaker on the stand
- » Fits speaker bottom holes from 35 mm - 40 mm (1.38" - 1.57").

Specifications

Height: 170 mm (6.7")

Weight: 0.8 kg (1.8 lbs.)

Size: 175 mm × 82 mm × 55 mm (7" × 3.2" × 2.2")



LS700B

Gear Up Lighting Stand

The HERCULES Gear Up Lighting Stand LS700B features the Quick-N-EZ Gear Up System, a square T-bar with clip for easy mounting, and dual-braced tripod leg construction.

Features

- » Quik-N-EZ Gear Up
- » Square steel T-Bar with clip for easy mounting
- » Built-in metal leg housing
- » Lightweight all-aluminum tubes
- » Reinforced dual-brace leg construction

Specifications

Height: 1,640 mm – 3,500 mm (64.6"–137.8")

Weight: 10.4 kg (22.9 lbs.)

Base radius: 920 mm (36.2")

Load capacity: 45 kg (99.2 lbs.)

Folded size: 1471 mm × 225 mm × 185 mm (58" × 9" × 7.3")

T-Bar length: 1220 mm (48")

Accept flange at 35 mm (1-3/8")



Quik-N-EZ Gear Up

(Patented)

Drive upper 2 shafts simultaneously and raise a speaker or light to full height quickly and easily.

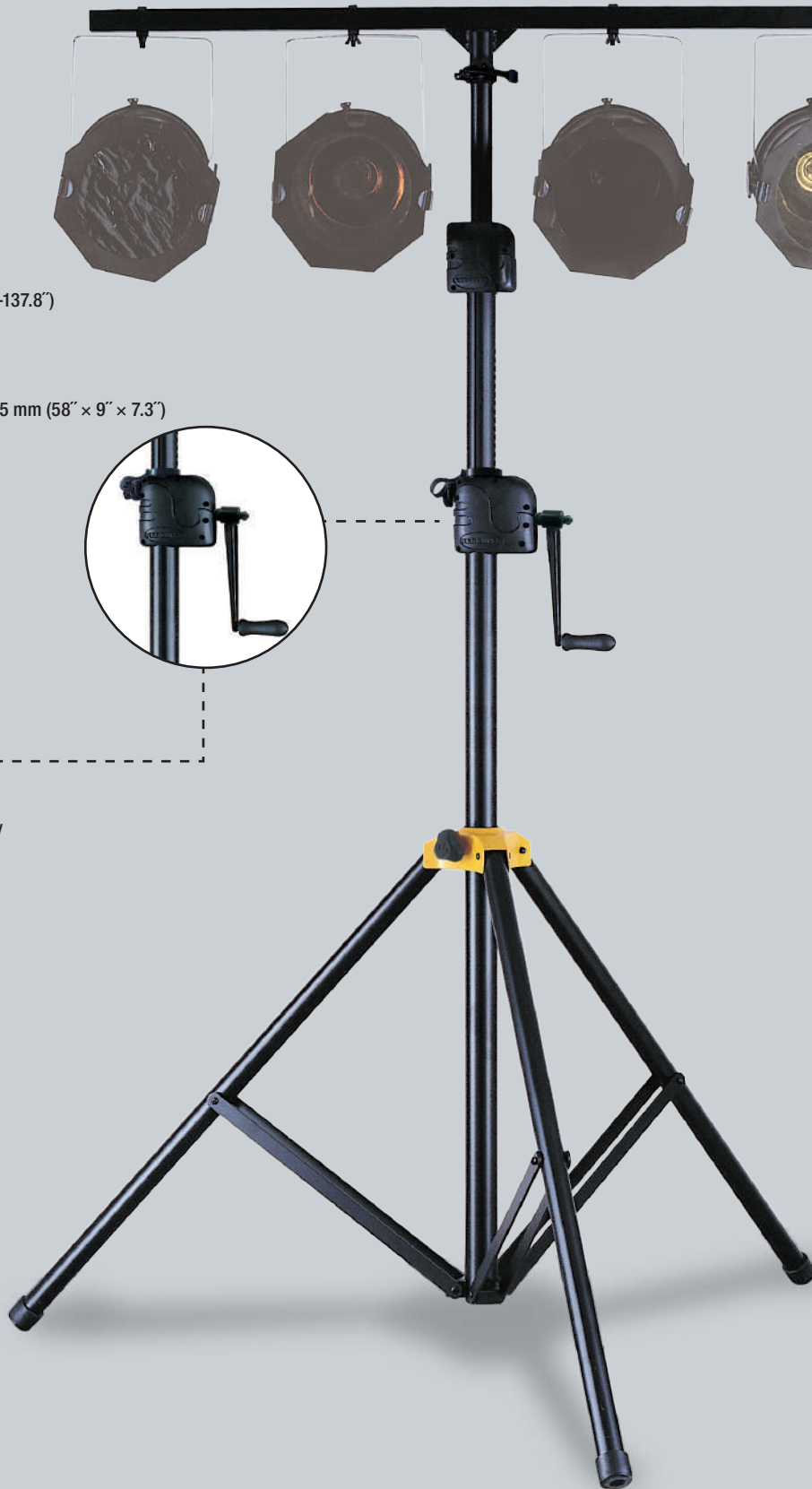





MULTIMEDIA STANDS

HERCULES provides comprehensive solutions for musicians to integrate technology with their music!

HERCULES multimedia stands are developed to meet all the demands of today's musicians accommodating tablets of all sizes, smartphones, laptops and more. Our stands are compatible with various sized and shaped tubes (round or square tubes) as well as table tops, desks, hi-hat stands and more.

Play music freely and flexibly with HERCULES multimedia stands.

DG107B**Universal Podcast Mic & Camera Arm Stand**

(Supports camera, microphone, DG207B, DG307B)

Features

- » TightVice™ locking & 360° rotating mechanism:
specialized locking mechanism holds device safely and tightly right in place
- » Built-in flexible ball joints and axes:
allows you to adjust the device to any angle that fit you needs
- » Wider support range:
1/4" - 20 camera screw thread, 3/8" mic thread, 3/8" - 5/8" mic thread adaptor
(connecting action cameras like GoPro or compact cameras)
- » More mounting options:
attach on desk, round and square tube for live broadcast, video or photo shooting

Specifications

Desk Thickness:

15.8 mm - 30 mm (0.6" - 1.2")

Tube Diameter:

Round Tube: 18 mm – 25.4 mm (0.7" - 1")

Square Tube: 10 mm – 25 mm (0.39" - 0.98")

Net Weight: 720 g (1.59 lbs.)

Load Capacity: 1 kg (2.2 lbs.)

Folded Size: 90 mm X 80 mm X 455 mm

(3.54" X 3.15" X 17.9")

Accessories: Hercules cable wraps included



TightVice™ locking &
360° rotating mechanism



Wider support range



More mounting options

DG207B

Smartphone Holder

(Supports 4.7"- 6.9" smartphones)

Features

- » TightVice™ locking & 360° rotating mechanism: specialized locking mechanism holds device safely and tightly right in place. With built-in flexible ball joints and axes, you can adjust the device to any angle that fit you needs
- » Adaptive applications: universal tripod and lighting connection for live broadcast, video or photo shooting
- » More mounting options: attach on desk, round and square tube for live broadcast, video or photo shooting

Specifications

Mounting Options:

¼"-20 threaded hole

Cold shoe socket

Adaptive desk/tube clamp

Desk Thickness:

15.8 mm - 30 mm (0.6" - 1.2")

Tube Diameter:

Round Tube: 18 mm – 25.4 mm (0.7" - 1")

Square Tube: 10 mm – 25 mm (0.39" - 0.98")

Net Weight: 320 g (0.71 lbs.)

Load Capacity: 1 kg (2.2 lbs.)

Folded Size:

205 mm X 90 mm X 75 mm (8.1" X 3.5" X 2.9")



DG307B

2-IN-1 Tablet & Phone Holder

(Supports 6.1"-13" smartphone or tablet)

Features

- » TightVice™ locking & 360° rotating mechanism: specialized locking mechanism holds device safely and tightly right in place. With built-in flexible ball joints and axes, you can adjust the device to any angle that fit you needs
- » More mounting options: attach on desk, round and square tube for live broadcast, video or photo shooting

Specifications

Mounting Options:

¼"-20 threaded hole

Adaptive desk/tube clamp

Desk Thickness:

15.8 mm - 30 mm (0.6" - 1.2")

Tube Diameter:

Round Tube: 18 mm – 25.4 mm (0.7" - 1")

Square Tube: 10 mm – 25 mm (0.39" - 0.98")

Net Weight: 570 g (1.26 lbs)

Load Capacity: 3 kg (6.6 lbs.)

Folded Size: 260 mm X 95 mm X 115 mm
(10.2" X 3.7" X 4.5")



DG400BB

Laptop Stand

Features

- » Adjusts easily for perfect height and angle
- » Extra rear-legs provide solid worry-free support to your laptops up to 10 kg (22lbs.)
- » One-piece design sets-up and tears down easily
- » Lightweight stand folds flat for easy transport and storage
- » Bag included

Specifications

3 Height Settings: 220 mm, 265 mm, 315 mm (8.6" × 10.4" × 12.4")

Weight: 1.4 kg (3.08 lbs.)

Load Capacity: 10 kg (22 lbs.)

Folded size: 360 mm × 175 mm × 66 mm
(14.1" × 6.9" × 2.6")

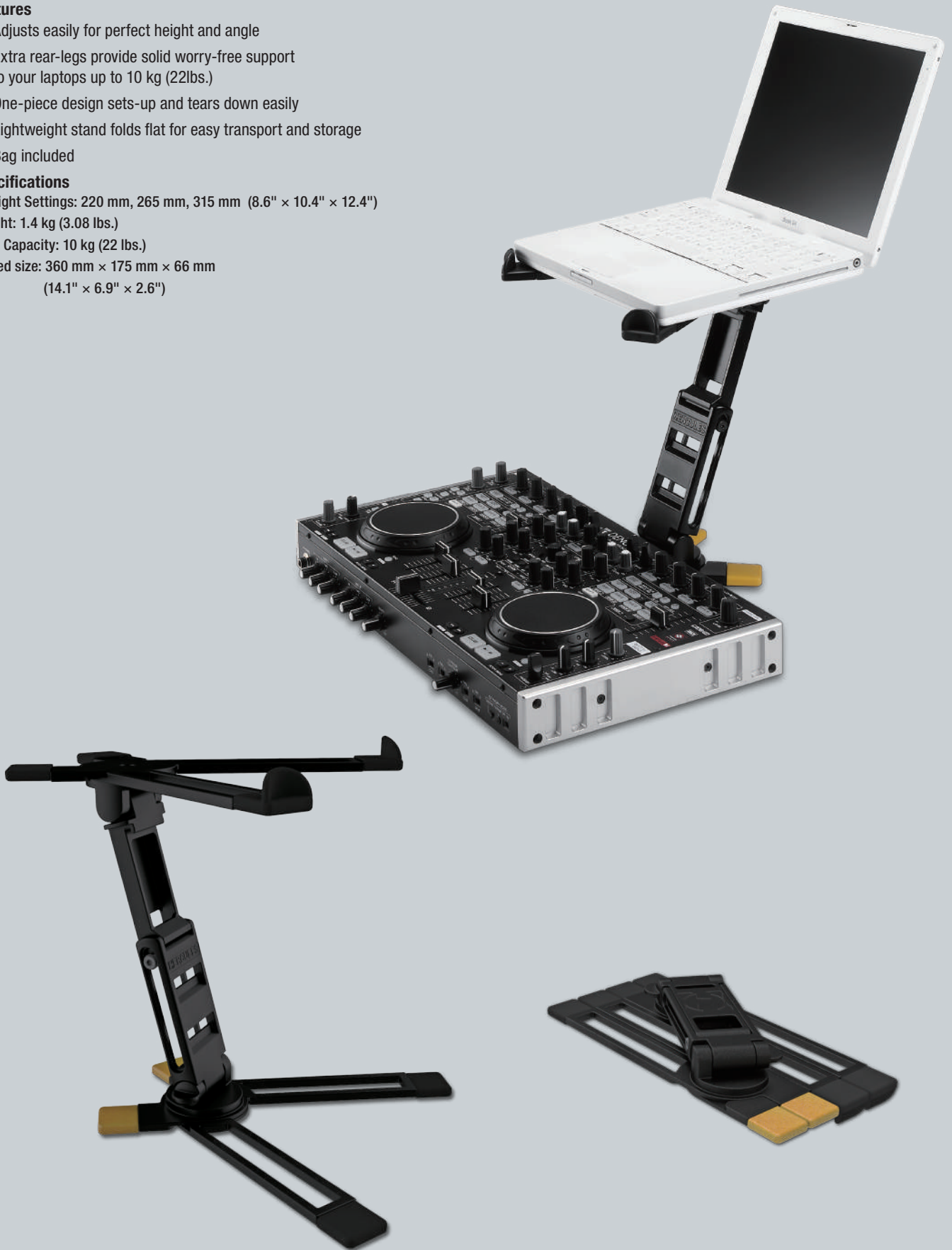

MUSIC STANDS

HERCULES Quik-N-EZ music stands are designed for easy tool-free adjustment, are lightweight, and secure.

HERCULES Quik-N-EZ music stands offer innovative solutions providing stands that are incredibly versatile and easy to use.



QUIK-N-EZ SERIES



Quik-N-EZ Retainer

Push the lever up or down to mount onto or dismount from desk or stand.



Quik-N-EZ Height Adjustment Grip

(Patented)

Squeeze the comfortable EZ Grip for fast one-handed height adjustments. An internal mechanism locks the stand in place when released.

BS418B

Orchestra Stand, Perforated Desk

Features

- » Aluminum perforated folding desk and page retainer
- » Quik-N-EZ Height Adjustment Grip
- » EZ Angle Roller with gripping rubber holds the desk at the desired angle
- » Three-section mechanism allows for lower position

Specifications

Desk: 480 mm x 345 mm (18.9" x 13.6")

Height: 610 mm - 1150 mm (24" - 45.3")

Weight: 3.15 kg (6.9 lbs.)

Base radius: 345 mm (13.6")

Load capacity: 5 kg (11 lbs.)

Folded size: 680 mm x 130 mm x 215 mm (26.7" x 5.1" x 8.5")



BS418B



BS408B

BS408B

Orchestra Stand, Solid Desk

Features

- » Aluminum solid folding desk and page retainer
- » Quik-N-EZ Height Adjustment Grip
- » EZ Angle Roller with gripping rubber holds the desk at the desired angle
- » Three-section mechanism allows for lower position

Specifications

Desk: 480 mm x 345 mm (18.9" x 13.6")

Height: 610 mm - 1150 mm (24" - 45.3")

Weight: 3.2 kg (7 lbs.)

Base radius: 345 mm (13.6")

Load capacity: 5 kg (11 lbs.)

Folded size: 680 mm x 130 mm x 215 mm (26.7" x 5.1" x 8.5")

**DESK TIPS****Folding Desk**

Sturdy and light aluminum. Fold the desk in half and secure it with the side locking pin. Press the pin to unfold.

Clips lock the desk in open position.

Desk can be used separately on table tops.

**EZ Angle Roller**

Simply adjust angle and tighten the side nut to adjust tension.

BS311B

Hercules Symphony Stand, Perforated Desk

Features

- » Aluminum perforated folding desk and page retainer
- » EZ Clutch
- » Tilting base which angles 90°-75° and swivel legs for crowded stages
- » Open taps for instrument pegs

Specifications

Desk: 480 mm x 345 mm (18.9" x 13.6")

Height: 680 mm – 1150 mm (26.8" – 45.3")

Weight: 3.05 kg (6.7 lbs.)

Base radius: 390 mm (15.4")

Load capacity: 5 kg (11 lbs.)

Folded size: 910 mm x 120 mm x 215 mm (36" x 4.7" x 8.5")



Open taps for peg

2 additional instrument peg holes allow the fitting of various pegs to store an instrument on the stand.

* Peg not included. Please refer to page 52 for peg individual purchase.

BS301B

Hercules Symphony Stand, Solid Desk

Features

- » Aluminum perforated folding desk and page retainer
- » EZ Clutch
- » Tilting base which angles 90°-75° and swivel legs for crowded stages
- » Open taps for instrument pegs

Specifications

Desk: 480 mm x 345 mm (18.9" x 13.6")

Height: 680 mm – 1150 mm (26.8" – 45.3")

Weight: 3.1 kg (6.8 lbs.)

Base radius: 390 mm (15.4")

Load capacity: 5 kg (11lbs.)

Folded size: 910 mm x 120 mm x 215 mm (36" x 4.7" x 8.5")



Tilting Base and Swivel Legs

(Patented)

The base can be angled 90° to 75° for comfortable positioning.

Swivel legs fit around other equipment, perfect for crowded stages.



Locking Ring - Simply pull up the locking ring to release legs for packing.



EZ Clutch - Press for a quick height adjustment.

BS200B**Hercules Symphony Stand, Solid Desk****Features**

- » EZ Height Adjustment Grip
- » Unique sturdy leg design
- » Stackable
- » Stores easily in BSC800 carry cart

Specifications

Height: 690 mm - 1100 mm (27.2" - 43.3")

Weight: 3.1 kg (6.8lbs.)

Base radius: 320 mm (12.6")

Load Capacity: 5 kg (11 lbs.)

Folded size: 492 mm × 122 mm × 580 mm (19.3" × 4.8" × 22.8")

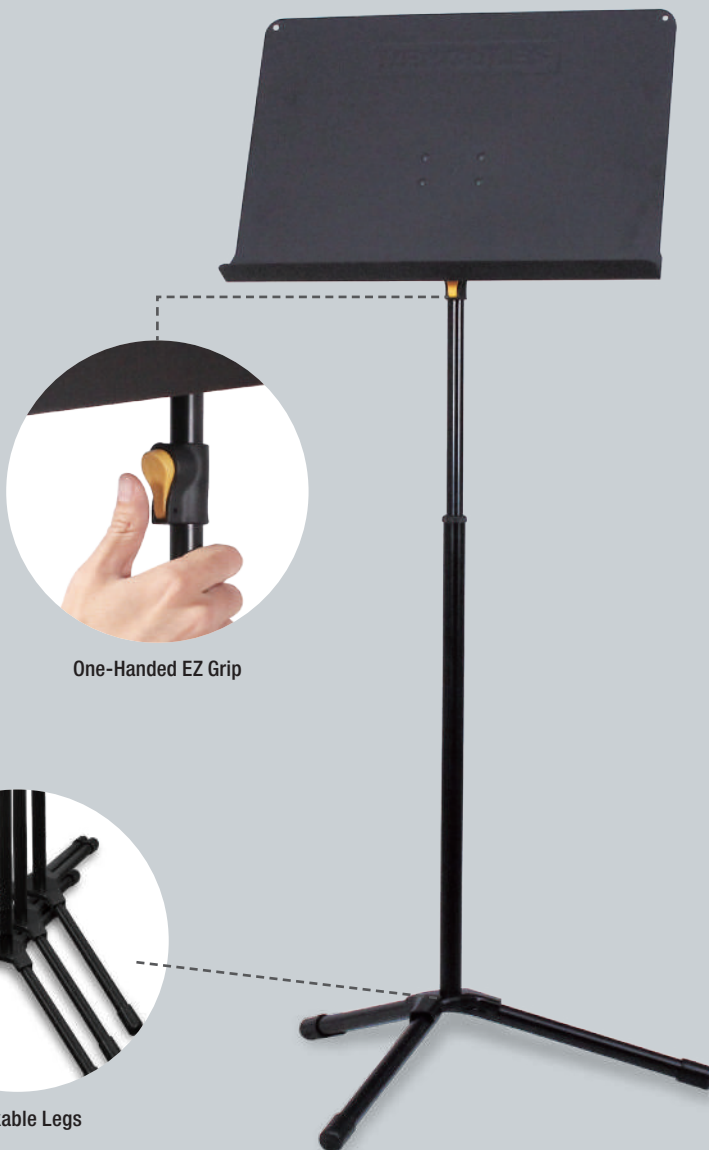

One-Handed EZ Grip

Stackable Legs

BSC800**Hercules Carry Cart**

Music stand cart carries up to 12 pieces of Hercules BS200B Symphony Stand, great for storing in tight spaces, transports stands easily.

Specifications

Height: 970 mm (38.2")

Weight: 10 kg (22 lbs.)

Load Capacity: 45 kg (99.2lbs.)

Base radius: 1100 mm x 500 mm (43.3" x 19.7")

Folded size: 495 mm x 156 mm x 1044 mm

(19.5" x 6.1" x 41.1")



BSB001

Carrying Bag

BS301B/ BS311B/ BS408B/ BS418B.

Also fits 2 of the following: DS520B, DS561B, DS538B, DS537B, DS535B, and DS536B.

**Please note that the 2 DS535B or DS536B stands should be put into the bag facing opposite directions.*

Features

- » Separate compartments for desk and stand to prevent scratching
- » Padded bottom protects the stand

Specifications

Size: 850mm × 130 mm × 210 mm (33.5" × 5.1" × 8.3")

Load capacity: 15 kg (33lbs.)



HA100

Mute Holder

Features

- » Designed to hold cornet, trumpet, trombone and French horn mutes
- » Ideal for keeping up to four mutes in a convenient and safe position during performances or practice.
- » Easy to use and adjust

Specifications

Weight: 0.5 kg (1.2 lbs.)

Load capacity: 5 kg (11 lbs.)

Folded size: 250 mm × 110 mm × 85 mm
(9.8" × 4.3" × 3.3")

Ring diameters:

74 mm (2.92") x 1

63 mm (2.48") x 2

47.5 mm (1.87") x 1



Detachable accessory tray included.



DS800B

Percussion Table Stand

Designed to safely support dozens of percussion and accessories items for all kinds of performances.

Features

- » High density wave foam and rubber edge
- » Foam is removable and replaceable
- » Table height is adjustable and ranges from 560 mm - 920 mm (22" × 36.2")

**Wave foam is replaceable if required.*

Specifications

Height: 560mm – 920mm (22" × 36.2")

Weight: 4.8 kg (10.6 lbs.)

Base radius: 385 mm (15.2")

Load capacity: 25 kg (55.1 lbs.)

Folded size: 615 mm × 130 mm × 485 mm
(24.2" × 5.1" × 19")

Table size: 470 mm x 600 mm (18.5" x 23.6")



Stands you can TRUST!



BS118BB

Three-Section EZ Grip Music Stand w/Bag

BS118B 3-section EZ Grip Music Stand w/bag is a three-section stand ideal for use while sitting or standing.

Features

- » Reinforced desk lip
- » EZ desk
- » EZ Angle Gripping Roller
- » EZ Grip for one-handed height adjustment
- » Three-section mechanism allows for low, mid and high positions
- » Carry bag Included

Specifications

Desk: 535 mm x 293 mm (21" x 11.5")

Height: 550 mm - 1230 mm (21.7" - 48.4")

Weight: 1.67 kg (3.7 lbs.)

Base radius: 340 mm (13.4")

Load capacity: 2.5 kg (5.5lbs.)

Folded size: 95 mm x 65 mm x 530 mm
(3.7" x 2.6" x 20.8")

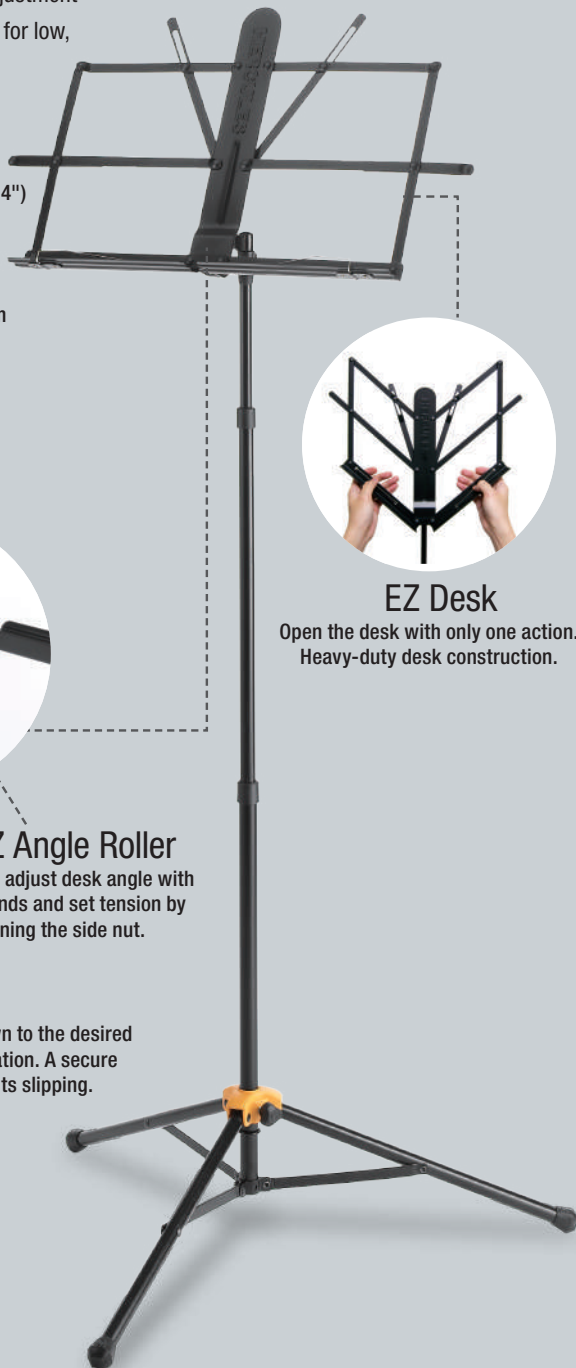

EZ Angle Roller

Instantly adjust desk angle with your hands and set tension by turning the side nut.

EZ Grip

The EZ Grip adjusts the stand up or down to the desired height with smooth one-handed operation. A secure internal locking mechanism prevents slipping.



EZ Desk

Open the desk with only one action.
Heavy-duty desk construction.

BS030BB

Compact Music Stand

Features

- » Compact folding music desk with 2 page retainers on the shelf sides
- » Strong tripod takes sheet music weighed up to 2.5 kg
- » Durable tube holders and knobs offer great stability and easily stretch to desired height

Specifications

Height: 600 mm - 1200 mm (2.36" - 47.3")

Weight: 1.1 kg (2.5 lbs.)

Base Radius: 300 mm (11.8")

Load Capacity: 2.5 kg (5.51 lbs.)

Folded Size: 90 mm x 50 mm x 390 mm
(3.6" x 2" x 15.4")



BS050B

3-Section Music Stand

BS050B EZ Desk Music Stand is a lightweight three-section music stand ideal for use while sitting or standing.

Features

- » EZ Desk
- » Three-section mechanism for low, mid and high level positioning
- » Carry bag Included

Specifications

Desk: 410 mm x 235 mm (16.1" x 9.3")
 Height: 530 mm - 1200 mm (20.8" - 47.2")
 Weight: 1.28 kg (2.8 lbs.)
 Base radius: 310 mm (12.2")
 Load capacity: 2.5 kg (5.5lbs.)
 Folded size: 85 mm x 55 mm x 470 mm
 (3.3" x 2.2" x 18.5")



BS100B

EZ Glide Music Stand

BS100B EZ Glide Music Stand is a lightweight stand ideal for use while sitting or standing.

Features

- » EZ Desk
- » EZ Angle Gripping Roller
- » EZ Glide

Specifications

Desk: 535 mm x 293 mm (21" x 11.5")
 Height: 690 mm - 1,240 mm
 (27.1" - 48.8")
 Weight: 1.45 kg (3.2 lbs.)
 Base radius: 330 mm (13")
 Load capacity: 3 kg (6.6 lbs.)
 Folded size: 110 mm x 85 mm x 675 mm
 (4.3" x 3.3" x 26.5")

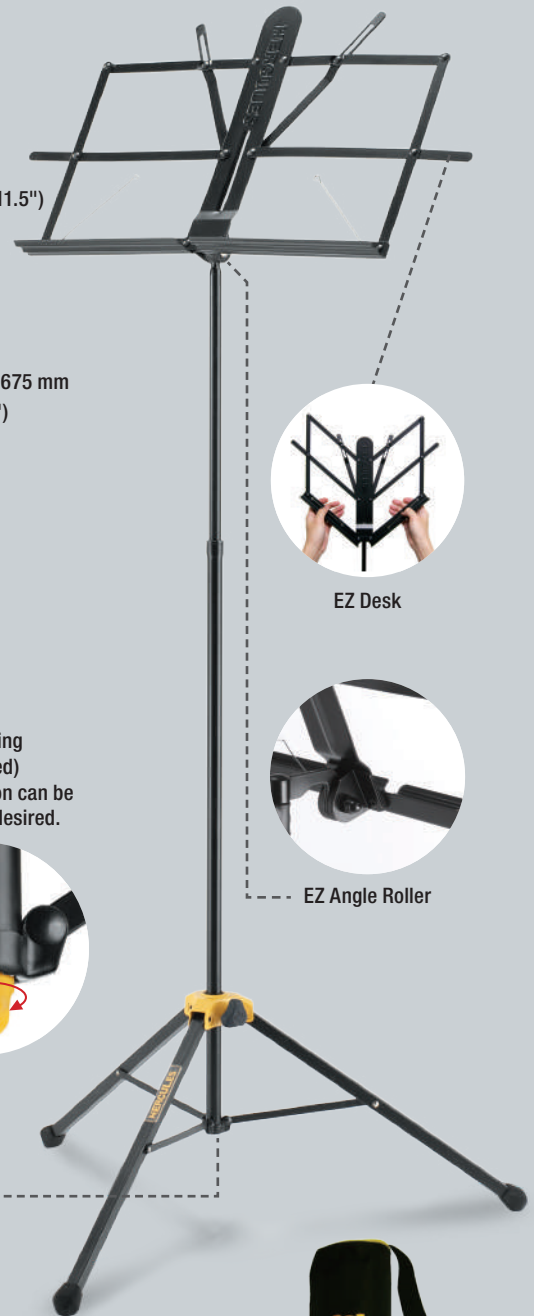

Reset Wing (Patented)
 EZ Glide tension can be adjusted as desired.



EZ Desk



EZ Angle Roller

BSB002

Carrying Bag for BS100B

Features

- » Circular zipper for quick access
- » Padded bottom protects the stand

Specifications

Size: 110 mm x 660 mm (4.3" x 26")
 Load capacity: 6 kg (13.2 lbs.)



RYAN MARSHALL
WALK OFF THE EARTH

WIND & STRINGED INSTRUMENT STANDS

HERCULES EZ-SAFE wind and stringed instrument stands are engineered with innovative safety features that keep the instrument safe and secure.

HERCULES EZ-SAFE instrument stands are stands you can TRUST for all your valuable instruments.



DS630BB**AGS Alto/Tenor Saxophone Stand****Features**

- » Unique AGS (Auto Grip System) design
- » Adjustable backrest
- » Locking pins on leg housing for easy transportation
- » Two extra peg holes on the legs
- » Carry bag included

Specifications

Height: 430 mm (16.9")

Weight: 0.98 kg (2.2 lbs.)

Base Radius: 235 mm (9.3")

Load capacity: 10 kg (22 lbs.)

Folded size: 115 mm x 100 mm x 310 mm
(4.5" x 3.9" x 12.2")

**DS730B****AGS Alto/Tenor Tall Saxophone Stand**

The Upright stand offers easy access of instrument, ideal for both standing and sitting performance.

Features

- » Unique AGS (Auto Grip System) Design
- » Adjustable backrest
- » Fits in GSB001 carry bag

Specifications

Height: 925 mm - 1325 mm (36.4" - 52.2")

Weight: 1.93 kg (4.3 lbs.)

Base Radius: 355 mm (14")

Load Capacity: 10 kg (22 lbs.)

Folded size: 155 mm x 125 mm x 500 mm
(6.1" x 4.9" x 19.7")

* Could fit in GSB001 carrying bag.

**AUTO GRIP SYSTEM**

The Auto Grip System (AGS) is driven by the weight of the Saxophone. When placing the bell on the trigger of the yoke, the arms slide down to secure the saxophone. When ready to play, simply lift up the instrument and the AGS releases automatically.





DS530BB

Alto/Tenor Saxophone Stand

Features

- » Folding yoke
- » Adjustable backrest
- » Locking pins on leg housing for packing
- » Carry bag included

Specifications

Height: 420 mm (16.5")
 Weight: 0.98 kg (2.2lbs.)
 Base radius: 260 mm (10.2")
 Load capacity: 10 kg (22 lbs.)
 Folded size: 140 mm × 155 mm × 320 mm
 (5.5" × 6.1" × 12.5")



DS532BB

Alto/Tenor Saxophone, Flute/Clarinet Stand

Features

- » Folding yoke
- » Adjustable backrest
- » Locking pins on leg housing for packing
- » Velvet flute/clarinet combo peg
- » Carry bag included

Specifications

Height: 420 mm (16.5")
 Weight: 1.05 kg (2.3 lbs.)
 Base radius: 260 mm (10.2")
 Load capacity: 10 kg (22 lbs.)
 Folded size: 140 mm × 155 mm × 320 mm
 (5.5" × 6.1" × 12.5")



DS533BB

Alto/Tenor, Soprano Saxophone Stand

Features

- » Folding yoke
- » Adjustable backrest
- » Locking pins on leg housing for packing
- » Velvet adjustable soprano saxophone peg
- » Carry bag included

Specifications

Height: 420 mm (16.5")
 Weight: 1.22 kg (2.68 lbs.)
 Base radius: 260 mm (10.2")
 Load capacity: 10 kg (22 lbs.)
 Folded size: 140 mm × 155 mm × 320 mm
 (5.5" × 6.1" × 12.5")

EZ-SAFE

Folding Yoke

(Patented)

The Folding Yoke sets up and packs down in seconds with a securing pin. Covered with SFF rubber to protect your instrument.



Adjustable Alto/Tenor Saxophone Backrest

Flip up the backrest to change positions instantly thus accommodating alto and tenor saxophone, and allowing one-piece packing. Covered with SFF rubber.



DS531BB

Soprano Saxophone Stand

Features

- » Velvet soprano saxophone peg
- » Swivel legs
- » Detachable peg for compact storage
- » Carry bag included

*Also holds flugelhorns

Specifications

Height: 350 mm (13.8")
 Weight: 0.67 kg (1.41 lbs.)
 Base radius: 170 mm (6.7")
 Load capacity: 5 kg (11 lbs.)
 Folded size: 138 mm x 96 mm x 338 mm
 (5.4" x 3.8" x 13.3")

**DS537B**

Duo Alto/Tenor Saxophone Stand

Features

- » Folding Yokes
- » Adjustable alto/tenor saxophone backrests
- » Locking pins on leg housing
- » One-piece design folds up compactly

Specifications

Height: 395 mm (15.6")
 Weight: 1.77 kg (3.9 lbs.)
 Base radius: 730 mm x 330 mm (28.7" x 13")
 Load capacity: 20 kg (44 lbs.)
 Folded size: 170 mm x 160 mm x 400 mm (6.7" x 6.3" x 15.7")

**DS538B**

Alto/Tenor, Soprano Saxophone and Flute/Clarinet Stand

Features

- » Folding yokes
- » Adjustable alto/tenor saxophone backrests
- » Locking Pins on leg housing
- » One-piece design folds up compactly
- » Three additional peg holes for the included saxophone and flute/clarinet pegs

Specifications

Height: 395 mm (15.6")
 Weight: 2.13 kg (4.7 lbs.)
 Base radius: 730 mm x 330 mm
 (28.7" x 13")
 Load capacity: 20 kg (44 lbs.)
 Folded size: 170 mm x 160 mm x 400 mm
 (6.7" x 6.3" x 15.7")

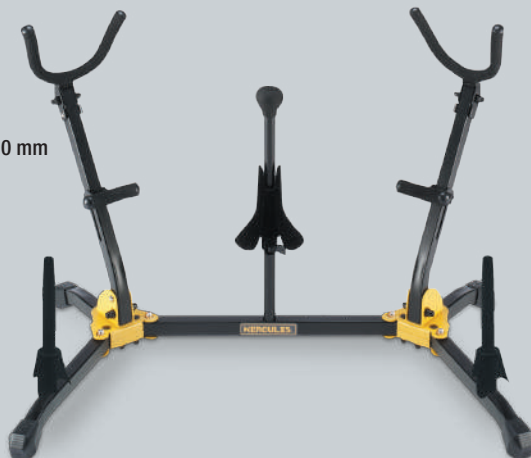

DS535B

Baritone Saxophone Stand

Features

- » Folding yoke
- » Lever height adjuster
- » Adjustable backrest
- » Swivel legs

Specifications

Height: 635 mm – 875 mm (25" - 34.4")

Weight: 2.1 kg (4.6 lbs.)

Base radius: 360 mm (14.2")

Load capacity: 20 kg (44 lbs.)

Folded size: 190 mm × 180 mm × 485 mm
(7.5" x 7" x 19")



To release EZ pin, slide the pin up and fold the upper post. To fold the legs, simply press the pins.



DS536B

Baritone and Alto/Tenor Saxophone Stand

Features

- » Folding yoke
- » Lever height adjustment
- » Patented Adjustable backrest
- » Extra peg for alto or tenor saxophone
- » Swivel legs

Specifications

Height: 635 mm – 875 mm (25" – 34.4")

Weight: 2.4 kg (5.4 lbs.)

Base radius: 360 mm (14.2")

Load capacity: 20 kg (44 lbs.)

Folded size: 190 mm × 180 mm × 485 mm
(7.5" x 7" x 19")



Flip the backrest up to adjust the position; Securely holds different types of baritone saxophones.



DS640BB

Flute/Clarinet Stand

Features

- » Velvet telescopic peg
- » Fits flutes and both French and German clarinets
- » Detachable peg for compact packing
- » Carry bag included

Specifications

Height: 265 mm (10.4")

Weight: 0.5 kg (1.1 lbs.)

Base radius: 135 mm (5.3")

Load capacity: 5 kg (11 lbs.)

Folded size: 99 mm × 79 mm × 214 mm (3.8" × 3.1" × 8.4")

**Telescopic peg**

(Patented)

The tapered peg shape and the self-shortening spring work together to ensure a snug fit and extra stability for long, tall instruments.

DS543BB

Flute, Clarinet and Piccolo Stand

Features

- » Two flute/clarinet combo pegs
- » One piccolo peg
- » Swivel legs
- » Detachable pegs for compact packing
- » Carry bag included

Specifications

Height: 220 mm (8.7")

Weight: 0.7 kg (1.5 lbs.)

Base radius: 170 mm (6.7")

Load capacity: 15 kg (33.1 lbs.)

Folded size: 93 mm × 76 mm × 207 mm
(3.6" × 3" × 8.1")



DS562BB

Alto Flute Stand

Features

- » Detachable peg design for easy storage
- » Easy set up
- » Sturdy construction
- » Two additional instrument peg holes
- » Carry bag included

Specifications

Height: 345 mm (13.6")

Weight: 0.68 kg (1.5 lbs.)

Base radius: 200 mm (7.87")

Load capacity: 5 kg (11 lbs.)

Folded size: 105 mm × 75 mm × 320 mm (3.6" × 3" × 12.5")



TAPS ON THE STANDS

MODEL NO.	PEGS INCLUDED (QTY)	EXTRA OPEN TAPS	EXTRA OPEN TAPS QTY
DS510BB	1	N	-
DS513BB	3	N	-
DS530BB	0	Y	2
DS531BB	1	N	-
DS532BB	1	Y	1
DS533BB	1	Y	1
DS535B	0	Y	2**
DS536B	1	Y	1
DS537B	0	Y	1
DS538B	3	N	-
DS543BB	3	N	-
DS561B	0	Y	2
DS562BB	1	Y	2
DS640BB	1	N	-

* All taps can accommodate any add-on pegs including DS501B, DS503B, DS504B, DS602B.

** One only fit alto/ tenor saxophone peg.



DS561B**Bass Clarinet/Bassoon stand****Features**

- » Multi-functional yoke
- » Base rest
- » Lever height adjuster

Specifications

Height: 670 mm -1010 mm (26.4" - 39.8")

Weight: 2.03 kg (4.5 lbs.)

Base radius: 450 mm (17.7")

Load capacity: 15 kg (33.1 lbs.)

Folded size: 162 mm × 160 mm × 643 mm (6.3" × 6.3" × 25.3")

**Multi-Function Display**

The bass clarinet can be placed facing towards or away from the stand for both playing and display purposes.

The unique base rest allows the bass clarinet to be held securely even with end pin extended.

**PEGS**

DS501B
Velvet Peg for
Trumpet / Cornet

Specifications
Top diameter:
25 mm (0.98")



DS503B
Velvet Peg for Soprano
Saxophone / Flugelhorn

Specifications
Top diameter:
40 mm (1.57")



DS504B
Velvet Peg for Piccolo

Specifications
Diameter: 10 mm (0.39")
Length from base:
122 mm (4.8")



DS602B (Patented)
Velvet Peg for Flutes and
French/German Clarinets

Specifications
Diameter: 19 mm (0.75")
Length: 150 mm - 212 mm (5.9" - 8.35")

DS510BB

Trumpet/Cornet Stand

Features

- » Velvet peg
- » Solid swivel legs
- » Detachable pegs for compact storage
- » Carry bag included

Specifications

Height: 350 mm (13.8")

Weight: 0.67 kg (1.47 lbs.)

Base radius: 170 mm (6.7")

Load capacity: 5 kg (11 lbs.)

Folded size: 138 mm × 96 mm × 338 mm
(5.4" × 3.8" × 13.3")



DS531BB

Flugelhorn Stand

Features

- » Adjustable velvet flugelhorn peg
- » Swivel legs
- » Detachable pegs for compact storage
- » Carry bag included
- * Also holds soprano saxophones

Specifications

Height: 350 mm (13.8")

Weight: 0.64 kg (1.41 lbs.)

Base radius: 170 mm (6.7")

Load capacity: 5 kg (11 lbs.)

Folded Size: 180 mm x 70 mm x 70 mm
(7.1" x 2.8" x 2.8")



DS513BB

Trumpet, Cornet and Flugelhorn Stand

Features

- » Pegs for trumpets/cornets
- » One peg for flugelhorn
- » Patented swivel legs
- » Detachable pegs for compact storage
- » Carry bag included

Specifications

Height: 350 mm (13.8")

Weight: 1.18 kg (2.6 lbs.)

Base radius: 260 mm (10.2")

Load capacity: 15 kg (33.1 lbs.)

Folded size: 138 mm × 96 mm × 338 mm (5.4" × 3.8" × 13.3")

DS520B**Trombone Stand****Features**

- » Velvet coated EZ Top Bracket
- » Securely holds slide braces adjustable
- » Fits in GSB001 carrying bag

Specifications

Height: 860 mm (33.8")

Weight: 1.6 kg (3.5 lbs.)

Base radius: 300 mm (11.8")

Load capacity: 5 kg (11 lbs.)

Folded size: 135 mm × 115 mm × 79 mm
(5.3" × 4.5" × 3.1")

**EZ Top Bracket**

Two beveled slots secure the slide braces. Adjust the width by twisting the center hand knob.

**DS550BB****French Horn Stand****Features**

- » Yokes and backrest coated with Specially Formulated Foam Rubber
- » 3 locking pins on the leg housing
- » One-piece design folds up compactly
- » Carry bag included

Specifications

Height: 320 mm (12.6")

Weight: 0.9 kg (2.1 lbs.)

Base radius: 320 mm (12.6")

Load capacity: 10 kg (22 lbs.)

Folded size: 100 mm × 82 mm × 285 mm
(4" × 3.2" × 11.2")

Yoke length: 60 mm (2.4")



DS551B

Sousaphone Stand

Features

- » Yokes and backrest coated with Specially Formulated Foam Rubber
- » Heavy-duty structure
- » Tripod legs for stability
- » Locking pins
- » Fast and secure setup
- » One-piece design folds up compactly

Specifications

Height: 1110 mm (43.7")

Weight: 4.7 kg (10.3 lbs.)

Base radius: 390 mm (15.4")

Load capacity: 30 kg (66.1 lbs.)

Folded size: 850 mm × 260 mm × 233 mm
(33.4" × 10.2" × 9.1")



DS552B

Tuba/Euphonium Baritone Horn/Alto Horn Stand

Features

- » Heavy-duty stand supports low brass instruments
- » Strong all-in-one compact design
- » Extended supports accommodate different sized instruments

Specifications

Height: 915 mm – 1075 mm (36"– 42.3")

Weight: 4.53 kg (10 lbs.)

Base radius: 420 mm (16.5")

Load capacity: 30 kg (66.1 lbs.)

Folded Size: 275 mm x 175 mm x 535 mm
(10.8" x 6.9" x 21.1")



DS553B**Tuba Performer Stand**

The DS553B was specially designed for student and professional musicians alike to safely support the tuba whether practicing or performing.

Features

- » Adjustable 3-position support
- » Strong, low-profile legs

Specifications

Height: 320 mm – 600 mm (12.6" - 23.6")

Weight: 2.28 kg (5.02 lbs.)

Load Capacity: 25 kg (55.1 lbs.)

Base radius: 235 mm (9.25")

Folded size: 106 mm × 101 mm × 585 mm (4.2" × 4" × 23")

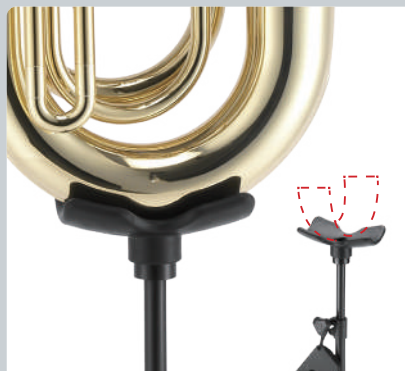

FOR STUDENTS
Makes practice enjoyable by helping
with positioning, breathing and posture



FOR PROFESSIONAL MUSICIANS
Provides full flexible support and
reduces neck and shoulder tension

The TravLite™ Series is designed for touring musicians who need light, portable and solid stands that can securely hold their valuable instrument. HERCULES TravLite stands store easily in the case, and hold the instrument securely.

DS431B

Alto Saxophone In-Bell Stand

(Patented)

Specifications

Height: 290 mm (11.4")

Weight: 0.38 kg (0.8 lbs.)

Base radius: 220 mm (8.7")

Load capacity: 15 kg (33.1 lbs.)

Folded size: 75 mm × 70 mm × 265 mm (3" × 2.8" × 10.4")



DS432B

Tenor Saxophone In-Bell Stand

(Patented)

Specifications

Height: 350 mm (13.8")

Weight: 0.4 kg (0.9 lbs.)

Base radius: 260 mm (10.2")

Load capacity: 15 kg (33.1 lbs.)

Folded size: 75 mm × 70 mm × 345 mm
(3" × 2.8" × 13.6")



Stand folds quickly and smoothly slips into the bell. A velvet bag is included for protection and easier inside the bell access.

DS440B

Clarinet In-Bell Stand

(Patented)

Features

- » Solid construction
- » Sturdy, lightweight and folds up compactly
- » Velvet pads protect the bell

Specifications

Height: 170 mm (6.7")

Weight: 0.1 kg (0.2 lbs.)

Base radius: 115 mm (4.5")

Load capacity: 3 kg (6.6 lbs.)

Folded size: 55 mm × 106 mm
(2.2" × 4.2")



Stores securely inside the bell for easy transport



DS460B

Flute In-Footjoint Stand

Specifications

Height: 148 mm (5.8")

Weight: 0.1 kg (0.2 lbs.)

Base radius: 165 mm (6.5")

Load capacity: 2.5 kg (5.5 lbs.)

Folded size: 19 mm × 128 mm (0.7" × 5")



Stand tucks away inside footjoint for the ultimate in compact storage



DS461B

Low B Flute In-Footjoint Stand

Features

- » Sets up easily
- » Solid, secure, folds and fits inside the footjoint

Specifications

Height: 175 mm (6.9")

Weight: 0.1kg (0.2 lbs.)

Base radius: 165 mm (6.5")

Load capacity: 2.5 kg (5.5 lbs.)

Folded size: 20 mm × 170 mm (0.8"× 6.7")

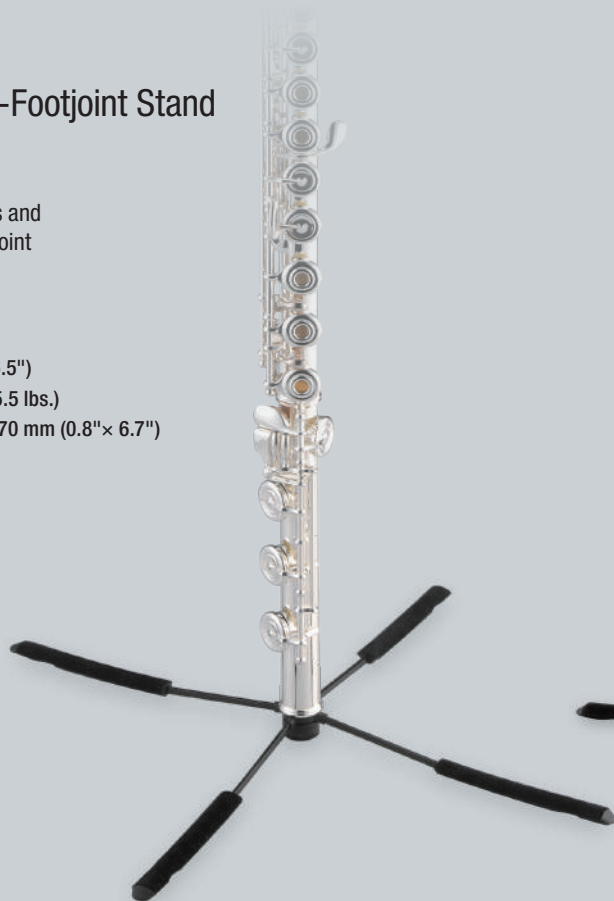

Stand tucks away inside footjoint for the ultimate in compact storage



DS410B

Trumpet In-Bell Stand

(Patented)

Features

- » Sturdy lightweight construction
- » Secure and safe storage
- » Folded, DS410B stores easily in velvet bag inside bell

Specifications

Height: 175 mm (6.9")

Weight: 0.28 kg (0.62lbs.)

Base radius: 170 mm (6.7")

Load capacity: 5 kg (11 lbs.)

Folded size: 180 mm × 70 mm × 70 mm
(7.1" × 2.8" × 2.8")

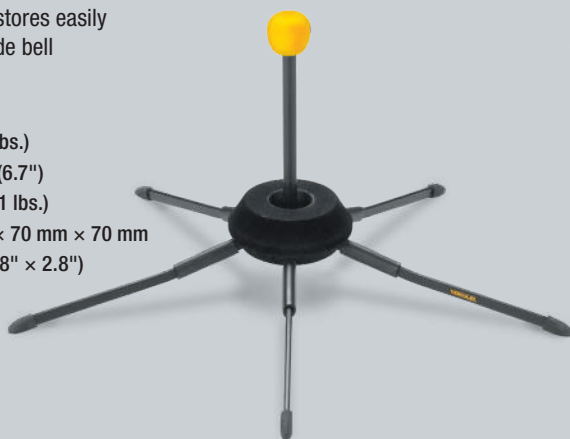

Slip into bell. A velvet bag is included for better protection and easier access inside the bell.



DS420B

Trombone In-Bell Stand

(Patented)

Features

- » Sturdy lightweight construction
- » Secure and safe storage
- » Folded, DS420B stores easily in velvet bag inside bell of instrument

Specifications

Height: 870 mm (34.2")

Weight: 1.23 kg (2.71 lbs.)

Base radius: 280 mm (11")

Load capacity: 5 kg (11 lbs.)

Folded size: 126 mm × 121 mm × 547 mm
(5" × 4.8" × 21.5")



Telescopic Tube

Height extender allows easy access during use and compact packing and storage



Stores perfectly inside the bell
Velvet bag is included

DS580B

Cello Stand

Features

- » AGS yoke
- » SSF Rubber covered legs
- » Extender accommodates increased stand height
- » Instrument can be stored with end-pin in playing position
- » Bow hook

Specifications

Height: 920 mm – 1200 mm (36.2" – 49.6")

Weight: 2.18 kg (4.8 lbs.)

Base radius: 450 mm (17.7")

Load capacity: 15 kg (33 lbs.)

Folded size: 182 mm x 125 mm x 712 mm
(7.2" x 5" x 28")

Fits ¼, ⅓, ½, ¾, ⅞ and full size cellos

* Could fit in GSB001 carrying bag.



Auto Grip System (AGS)

Cradle the cello peg box on the AGS. The weight of the cello lifts the front levers, securing the instrument on to the stand. Lift the instrument to release.



DS590B

Double Bass Stand

Features

- » Sturdy steel construction
- » 2 locking pins for secure and easy set up
- » Bow hook
- » One-piece folding design

Specifications

Height: 900 mm (35.4")

Weight: 3.47 kg (7.63 lbs.)

Base radius: 530 mm x 630 mm (20.9" x 24.8")

Load capacity: 50 kg (110 lbs.)

Folded size: 700 mm x 110 mm x 920 mm
(27.5" x 4.3" x 36.2")

Fits ¾ and full size double bass



DS571BB

Violin/Viola Stand

Features

- » Sturdy, lightweight aluminum stand with bow hook
- » Innovative Auto Grip System (AGS)
- » Folds compactly for easy carrying
- » Three-section design
- » Bow hook
- » Carry bag included

Specifications

Height: 420 mm - 670 mm (16.5" - 26.4")

Weight: 0.59 kg (1.3 lbs.)

Base radius: 250 mm (9.8")

Load capacity: 5 kg (11 lbs.)

Folded size: 99 mm × 84 mm × 475 mm
(3.9" × 3.3" × 18.7")

Fits ¼, ⅜, ½, ¾, 7⁄8 and full size violins and 12-17" violas

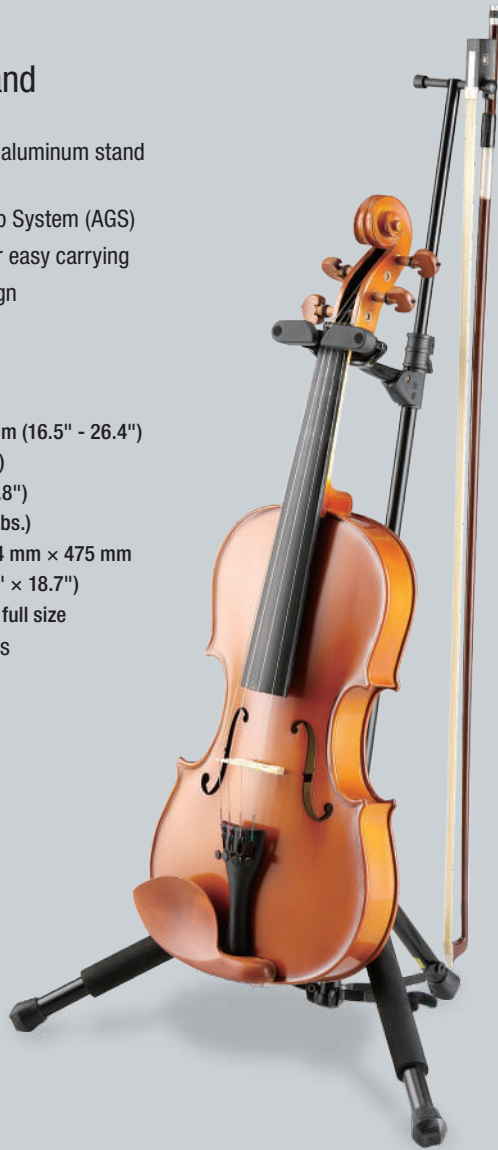

Detachable Utility Holder

Auto Grip System (AGS)

(Patented)

Cradle the violin/viola peg box on the AGS. The weight of the violin lifts the front levers, securing the instrument on the stand. Lift the instrument to release.



VIOLIN/VIOLA WALL DISPLAYS

AGS Violin/Viola Hangers safely and securely store small stringed instruments

For store or home use and will also fit mandolin, ukulele and most 5-string banjos.

Specifications

Load Capacity: 5 kg (11 lbs.)

Fits: ¼, ⅜, ½, ¾, 7⁄8 and full size Violins and 12"-17" Violas



DSP57WB

Wood Base Wall Mount



DSP57SB

Slatwall Mount

CASSANDRA **SOTOS**
SUNSET RISING / INDEPENDENT





PRODUCT **CATALOG** 